



For Future Energy & Environment -

# World Energy



**Absorption Chiller**  
**Absorption Chiller & Heater**  
**Absorption Heat Pump**



**High Efficiency**  
series





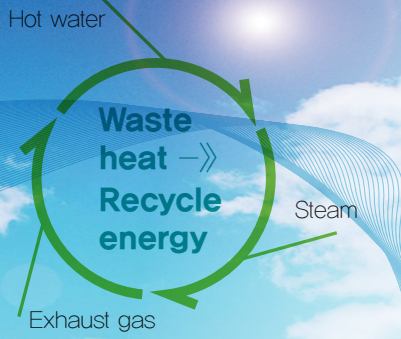

## About World Energy

**World Energy** has developed and sold various types of heat recovery products.

The core product is the Absorption Chiller, which is driven by heat sources like hot water, gas & oil firing, steam, and exhaust gas. World Energy has a wide range of Absorption Chillers and Heat Pumps that can be adapted to the specific needs of customers worldwide.

With its technology in development and manufacture of absorption machines meeting international standards, World Energy has provided products for domestic and global markets.

World Energy has offered energy efficient products to help Korean industrial area resolve energy challenges, by utilizing the exhaust heat. In cooperation with KDHC (Korean District Heating Corporation) and KARSE (Korean Association of Air Conditioning, Refrigerating and Sanitary Engineers), World Energy has contributed to Korean district cooling and heating industry for the technology development and the introduction of new certification programs.

World Energy also has supplied products to major players of fuel cell and cogeneration system industry in America, Asia, Europe and Oceania.

World Energy makes every effort to satisfy customers with improving customers' business interest by offering energy-saving and environmentally friendly products.

## World Energy Certificate



• Quality Management System Certificate

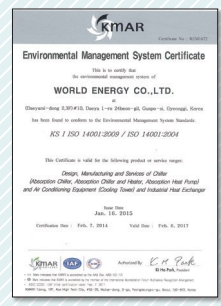

• Environmental Management System Certificate

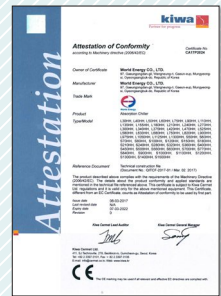

• CE Certificate

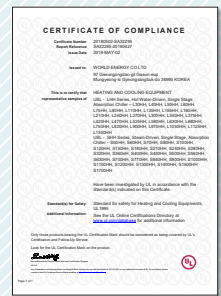

• Underwriters Laboratories



• Certificate of Designation of Excellent Product

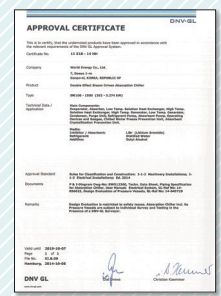

• GL Certificate



## Research & Development

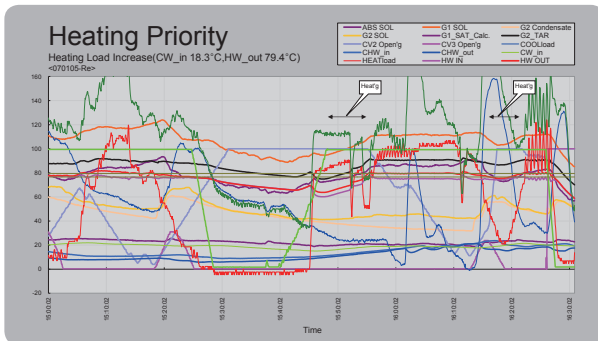

▲ Simultaneous Absorption Chiller & Heater



▲ 1st Generation Single Effect Double Lift Hot Water Driven Absorption Chiller



▲ Heat Exchanger Customized to Fuel Cell



▲ Maritime Absorption Chiller

▲ High COP Single Effect 2-Lift Hot Water Driven Absorption Chiller



## Company History

- **2004** Established World Energy Limited Co., Ltd.  
Developed Standard COP Absorption Chillers (DW, S, SW, HWAR-L Series)
- **2005** Developed Single Effect 2-Lift Hot Water Driven Absorption Chiller (2AB) with Korea District Heating Corporation
- **2007** UL Listed (Low Temperature Hot Water Driven Absorption Chiller (HWAR-L Series)
- **2008** Developed Heating Cycle for 2AB with Korea District Heating Corporation  
Developed Explosion Proof Type Absorption Chiller  
Established Certification Criteria of Hot Water Driven Absorption Chiller for District Heating Network with Korea District Heating Corporation
- **2009** Developed Vacuum Distillation Recycling System with Ministry of Environment Republic Korea  
Developed Low Temperature Hot Water (70°C) Driven Absorption Chiller (2AA) for Industrial Area  
Developed Heat Exchanger for UTC Power's Fuel Cell Cycle Upgrade of 2AB Series
- **2010** Developing Heat Exchanger (Evaporating Condenser) for MVR ( Mechanical Vapor Re-compressor)  
Developed High COP Absorption Chillers DWH, SWH, HWAR-LH
- **2011** Developed High COP Single Effect Absorption Chiller (COP 0.8) and Enclosure Type Absorption Chiller
- **2012** Developed Maritime type Absorption chiller with Small & Medium Business Administration and Acquired GL Certificate.  
Development of High COP (1.3 based on HHV) Direct Fired Absorption Chiller
- **2013** Developed 2-Effect 2-Lift Absorption Heat Pump For Heat Recovery From Sewage with Ministry of Environment Republic Korea
- **2016** Developed Cooling Module for Fuel Cells



# Line up World Energy Absorption Chiller

→ →

Heat source	Model No.	Type	Mode	Capacity						COP	Page
				usRT	20~50	60~80	100~150	560~1500	1600~2000		
				kW	70~175	210~281	351~527	1969~5274	5626~7033		
Hot water	 HWAR-L *** HH	Single effect 	Cooling							0.83	p.6
	 HWAR-L *** H	Single effect High efficiency	Cooling							0.8	p.8
	 2ABH ***	Single effect Double lift 	Cooling							0.71	p.12
	 2AB ***	Single effect Double lift	Cooling							0.64	p.14
	 2AA ***	Waste heat recovery Single effect	Cooling							0.41	p.18
GAS OIL	 DW *** HH	Double effect Direct fired type 	Cooling Heating							1.32	p.22
	 DW *** H	Double effect Direct fired type 	Cooling Heating							1.22	p.24
	 DW ***	Double effect Direct fired type	Cooling Heating							1.00	p.26
	 HPD ***	Heat pump	Heating	576Mcal/h~4030Mcal/h						1.65	p.50



World Energy Absorption Chiller Line up

Heat source	Model No.	Type	Mode	Capacity						COP	Page
				usRT	20~50	60~80	100~150	560~1500	1600~2000		
				kW	70~175	210~281	351~527	1969~5274	5626~7033		
Steam	SWHH *** 	Double effect <b>Super High Efficiency</b>	Cooling				100RT		2000RT	1.48	p.30
	SWH *** 	Double effect	Cooling				100RT		1600RT	1.36	p.32
	S *** HH 	Single effect <b>Super High Efficiency</b>	Cooling				50RT		2000RT	0.81	p.34
	SWM *** 	Double effect Marine chiller	Cooling				50RT		1100RT	1.21	p.36
	HPS *** 	Heat pump	Heating				576Mcal/h~4030Mcal/h			1.8	p.50
Exhaust gas	CHP *** H 	Double effect <b>High Efficiency</b>	Cooling Heating				50RT		1500RT	1.36	p.40
	CHP *** 	Double effect	Cooling Heating				50RT		1500RT	1.2	p.42
Hot water & Exhaust gas	CHPL *** H 	Hybrid chiller	Cooling				374RT ~1248RT			1.1 ~ 1.23	p.46

# Single Effect Hot Water Driven Absorption Chiller

## HWAR-LHH Series

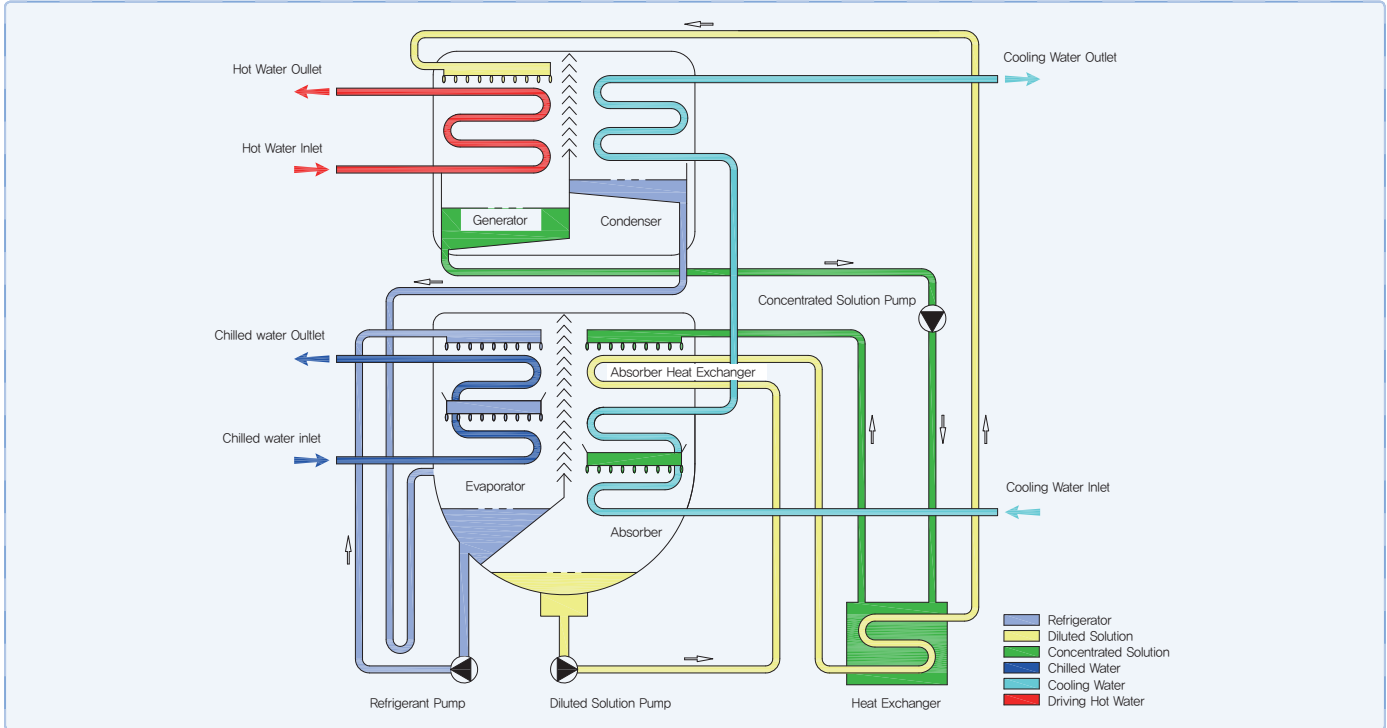

## 2AA series

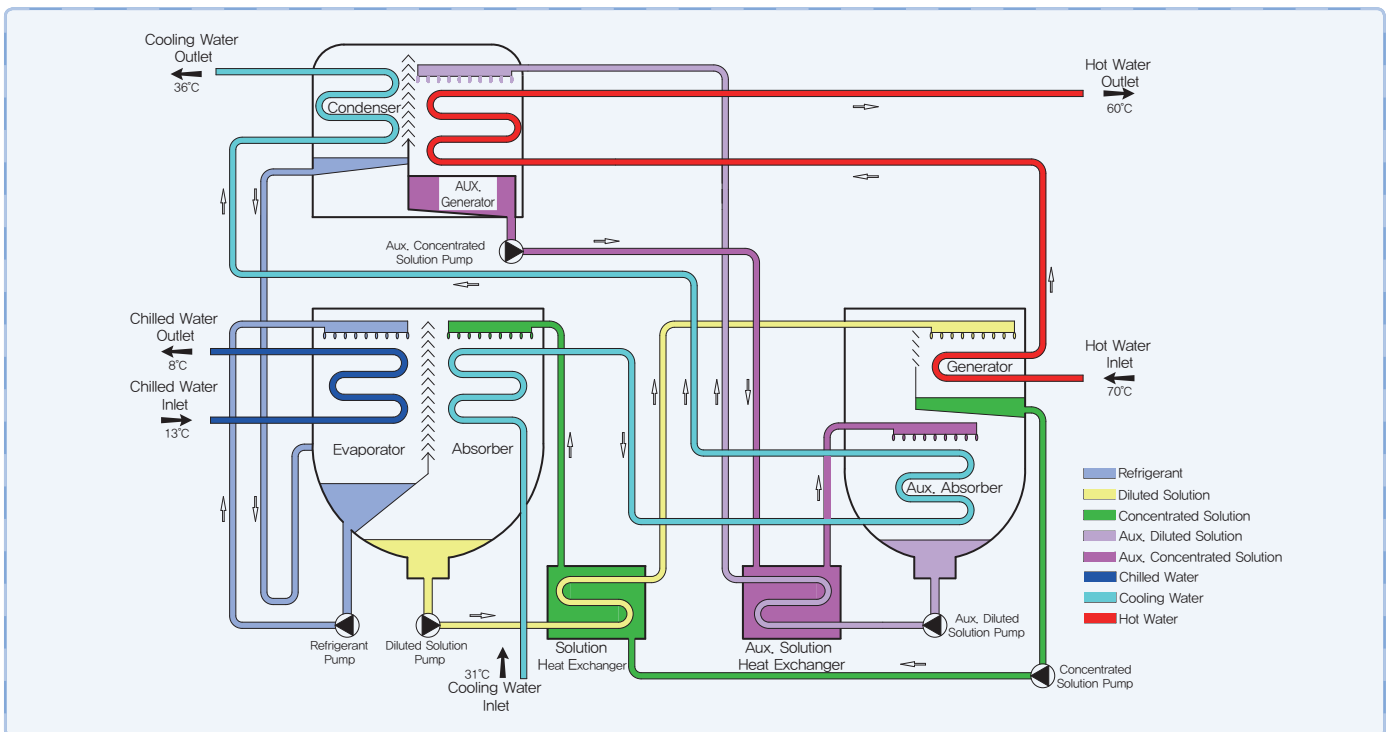



2ABH series

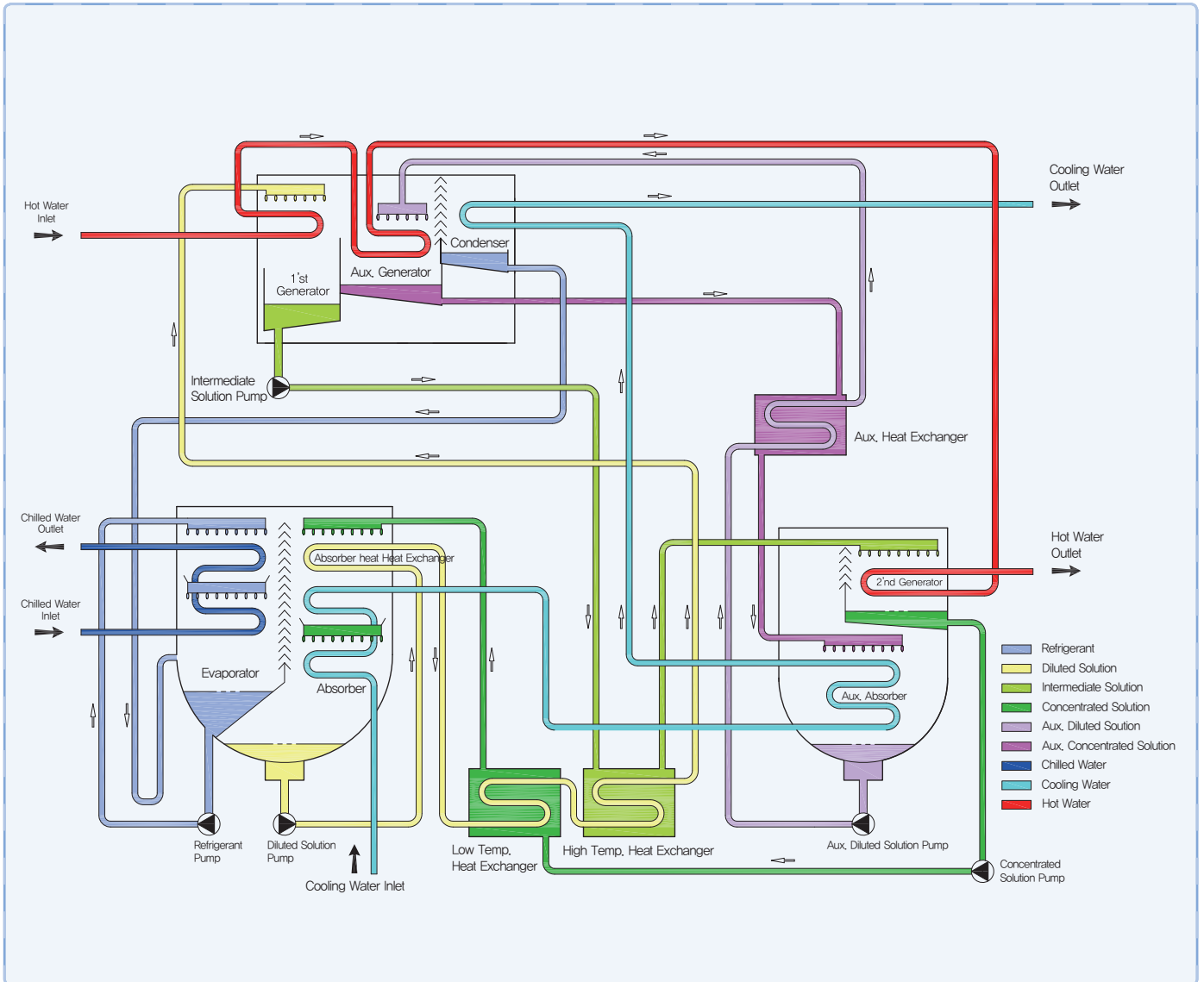

**2-Lift** Hot water driven absorption chiller has a main cycle and an aux. cycle. The chilled water is cooled down twice by refrigerant from double tray in the evaporator and the vaporized refrigerant is absorbed into concentrated solution which is coming from 2nd generator. The quantity of Vapor that can be absorbed in the absorber is increased by double tray system. The concentrated solution becomes diluted solution and the heat is absorbed into cooling water. The diluted solution in absorber flows to 1st generator through low temp. heat exchanger and high temp. heat exchanger, and 95°C hot water heats up the diluted solution and refrigerant is vaporized. Absorbent solution becomes intermediate solution in 1st generator and it flows to 2nd generator through high temp. heat exchanger.

The intermediated solution in 2nd generator is heated by hot water and refrigerant is vaporized in 2nd generator. The vapor is absorbed into absorbent solution in aux. absorber to become aux. diluted solution. The aux. diluted solution is delivered to aux. generator through aux. heat exchanger, and the solution is heated by hot water coming from 1st generator and becomes aux. concentrated solution. The aux. concentrated solution is delivered to aux. absorber through aux. heat exchanger. The refrigerant vapors which are generated in the 1st generator and aux. generator are condensed in condenser and then flow into evaporator, and the heat in condenser is absorbed by cooling water.

# Single Effect Hot Water Driven Absorption Chiller



## Performance Data

Model		Unit	L30HH	L40HH	L50HH	L60HH	L75HH	L90HH	L110HH	L135HH	L155HH	L180HH	L210HH	L240HH	L270HH	L300HH	
Cooling Capacity		kW	105	141	176	211	264	316	387	475	545	633	738	844	949	1,055	
		usRT	30	40	50	60	75	90	110	135	155	180	210	240	270	300	
Chilled Water	Inlet Temp./Outlet Temp.	°C	12 / 7														
	Flow rate	m <sup>3</sup> /h	18.1	24.2	30.2	36.3	45.4	54.4	66.5	81.6	93.7	108.9	127.0	145.2	163.3	181.4	
	Pressure Drop	mH <sub>2</sub> O	4.6	5.2	6.1	6.8	6.7	6.9	4.6	4.9	4.5	4.5	9.9	9.7	10.2	10.2	
	Connection	mm	65			80			100			125			150		
Cooling Water	Inlet Temp./Outlet Temp.	°C	30 / 35														
	Flow rate	m <sup>3</sup> /h	40.1	53.5	66.9	80.3	100.3	120.4	147.2	180.6	207.4	240.8	281.0	321.1	361.2	401.4	
	Pressure Drop	mH <sub>2</sub> O	4.3	4.8	7.1	7.7	7.3	7.7	9.6	10.5	10.8	10.7	9.2	8.8	9.0	9.0	
	Connection	mm	100			125			150			200					
Hot Water	Inlet Temp./Outlet Temp.	°C	95 / 80														
	Flow rate		ton/h	7.3	9.8	12.2	14.7	18.3	22.0	26.9	33.0	37.9	44.0	51.3	58.6	66.0	73.3
	Flow rate		m <sup>3</sup> /h	7.6	10.2	12.7	15.2	19.1	22.9	27.9	34.3	39.4	45.7	53.3	61.0	68.6	76.2
	Pressure Drop	Shell	mH <sub>2</sub> O	1.1	2.4	4.2	5.0	4.2	4.4	5.1	5.4	3.8	4.1	4.1	4.2	3.9	4.1
		Control Valve	mH <sub>2</sub> O	4.0	2.9	4.5	2.4	3.8	2.2	3.3	1.9	2.5	3.4	4.7	2.4	3.1	3.8
	Connection	mm	50			65			80			100					
Control Valve	mm	40			50			65			80			100			
Electric	Power source	-	3PH 400V, 50Hz														
	Abs. Pumps	kW(A)	0.3(1.4)			0.4(1.4)			0.4(1.4)			0.3(1.4)			1.5(4.3)		
	Ref. Pump	kW(A)	0.2(1.2)						0.3(1.4)								
	Purge Pump	kW(A)	0.4(1.4)														
	Control Panel	kW(A)	0.2(0.5)														
	Total kW	kW	1.1			1.2			1.3			2.4					
	Total Ampere @400V	A	4.5						4.7						7.6		
Size	Length (L)	mm	2,110		2,610		2,658		3,678		3,728		4,748		4,860		
	Width (W)	mm	1,156				1,267				1,409				1,451		
	Height (H)	mm	2,131				2,351				2,660				2,736		
Weight	Rigging	ton	2.5	2.5	2.9	2.9	3.5	3.5	4.3	4.5	5.3	5.5	6.4	6.7	8.1	8.3	
	Operation	ton	2.8	2.9	3.3	3.4	4.0	4.1	5.0	5.3	6.3	6.7	7.7	8.1	9.7	10.1	
Space for Tube Replacement		mm	1,900			2,400			3,400			4,600					
Water Volume of Machine	Chilled Water Side	ℓ	60	67	77	80	111	123	142	159	216	237	258	286	324	348	
	Cooling Water Side	ℓ	215	235	265	276	309	336	391	432	569	622	694	765	927	993	
	Hot Water Side	ℓ	61	68	79	83	108	118	139	154	184	202	224	248	311	332	

### Note

- Working pressure of each water side is based on 1.0MPa (150psig)
- Fouling factor 0.0001 m<sup>2</sup>.hr. °C/Kcal for Absorber, Condenser and Evaporator.
- Min. outlet temp. of chilled water: 5°C
- Min. allowable inlet temp. of cooling water: 20°C.
- Controllable range shall be 0~100%.
- Standard Power source is 3ph, 400V, 50Hz and available 220, 380, 440V and 460V power source.
- Each water flow can be adjusted within 50~120%.



# LHH Series

## Single Effect Hot Water Driven Absorption Chiller

### Performance Data

Model		Unit	L340HH	L375HH	L420HH	L470HH	L525HH	L580HH	L630HH	L680HH	L750HH	L820HH	L900HH	L975HH	L1050HH	L1125HH	L1300HH	
Cooling Capacity		kW	1,196	1,319	1,477	1,653	1,846	2,039	2,215	2,391	2,637	2,883	3,165	3,428	3,692	3,956	4,571	
		usRT	340	375	420	470	525	580	630	680	750	820	900	975	1,050	1,125	1,300	
Chilled Water	Inlet Temp./Outlet Temp.	°C	12 / 7															
	Flow rate	m <sup>3</sup> /h	205.6	226.8	254.0	284.3	317.5	350.8	381.0	411.3	453.6	495.9	544.3	589.7	635.0	680.4	786.2	
	Pressure Drop	mH <sub>2</sub> O	9.2	9.7	4.4	5.9	5.6	7.4	9.2	5.5	7.1	9.1	6.9	8.6	5.2	6.4	9.5	
	Connection	mm	200					250					300					
Cooling Water	Inlet Temp./Outlet Temp.	°C	30 / 35															
	Flow rate	m <sup>3</sup> /h	454.9	501.7	561.9	628.8	702.4	776.0	842.9	909.8	1003.4	1097.1	1204.1	1304.4	1404.8	1505.1	1739.3	
	Pressure Drop	mH <sub>2</sub> O	9.3	9.3	8.4	11.3	8.2	10.6	13.3	8.2	11.2	13.5	10.2	12.7	8.8	10.8	13.1	
	Connection	mm	250					300					350					
Hot Water	Inlet Temp./Outlet Temp.	°C	95 / 80															
	Flow rate	ton/h	83.1	91.6	102.6	114.9	128.3	141.7	153.9	166.2	183.3	200.4	219.9	238.3	256.6	274.9	317.7	
		m <sup>3</sup> /h	86.4	95.3	106.7	119.4	133.4	147.3	160.0	172.7	190.5	208.3	228.6	247.7	266.7	285.8	330.2	
	Pressure Drop	Shell	mH <sub>2</sub> O	4.0	4.1	2.7	3.6	3.3	4.3	5.4	3.4	4.3	5.4	3.8	4.7	3.6	4.4	2.5
		Control Valve	mH <sub>2</sub> O	4.9	2.3	2.8	3.6	4.4	2.4	2.8	3.3	4.0	4.4	1.7	2.0	2.4	2.7	3.6
	Connection	mm	125					150					200					
	Control Valve	mm	100	125					150					200				
Electric	Power source	-	3PH 400V, 50Hz															
	Abs. Pumps	kW(A)	1.5(4.3)					1.8(6.0)					2.2(6.7)					
	Ref. Pump	kW(A)	0.4(1.4)					1.5(4.0)					1.8(6)					
	Purge Pump	kW(A)	0.4(1.4)					0.75(2.2)										
	Control Panel	kW(A)	0.2(0.5)															
	Total kW	kW	2.5					3.9					5.0					
	Total Ampere @400V	A	7.6					11.9					15.4					
Size	Length (L)	mm	4,872		5,414	5,912	6,012	6,537	7,037	6,114	6,639	7,139	6,749	7,249	6,966	7,466	8,466	
	Width (W)	mm	1,588					2,031					2,320					
	Height (H)	mm	2,904					3,118					3,362					
Weight	Rigging	ton	10.1	10.4	11.5	12.3	15.6	16.9	17.9	21.5	23.0	24.5	28.0	29.6	37.3	39.4	43.7	
	Operation	ton	12.4	12.8	14.1	15.1	19.0	20.3	21.5	27.3	28.1	29.9	34.8	36.8	46.9	49.4	54.7	
Space for Tube Replacement	mm	4,600			5,200	5,700			6,200	6,700	5,700	6,200	6,700	6,200	6,700	6,300	6,800	7,800
Water Volume of Machine	Chilled Water Side	ℓ	465	485	526	563	656	701	744	944	1,004	1,060	1,355	1,423	1,795	1,890	2,079	
	Cooling Water Side	ℓ	1,252	1,325	1,425	1,517	1,959	2,082	2,199	2,579	2,738	2,890	3,563	3,746	4,691	4,919	5,377	
	Hot Water Side	ℓ	381	406	444	479	563	604	642	781	837	890	1,036	1,102	1,354	1,434	1,594	

### Option

1. Non-standard cooling capacity.
2. Higher working pressure (230psig = 1.6MPa, 300psig = 2.0MPa)
3. Special tubes (material) & thickness.
4. Various temp. conditions (CHW, CW, HW)
5. Outdoor installation.
6. The specifications above are subject to change without prior notice for an improvement of the chiller.

# Single Effect Hot Water Driven Absorption Chiller



## Performance Data

Model		Unit	L30H	L40H	L50H	L60H	L75H	L90H	L110H	L135H	L155H	L180H	L210H	L240H	L270H	L300H		
Cooling Capacity		kW	105	141	176	211	264	316	387	475	545	633	738	844	949	1,055		
		usRT	30	40	50	60	75	90	110	135	155	180	210	240	270	300		
Chilled Water	Inlet Temp./Outlet Temp.	°C	13 / 8															
	Flow rate	m <sup>3</sup> /h	18.1	24.2	30.2	36.3	45.4	54.4	66.5	81.6	93.7	109	127	145	163	181		
	Pressure Drop	mH <sub>2</sub> O	4.9	5.5	6.2	7.5	6.4	6.8	9.6	10.6	9.5	10.2	9.7	10.1	10.3	10.6		
	Connection	mm	65			80			100			125			150			
Cooling Water	Inlet Temp./Outlet Temp.	°C	31 / 36.5															
	Flow rate	m <sup>3</sup> /h	37.3	49.8	62.2	74.6	93.3	112	137	168	193	224	261	299	336	373		
	Pressure Drop	mH <sub>2</sub> O	4.1	4.4	6.6	8.4	6.7	7.0	3.4	3.8	3.9	4.1	7.8	7.7	7.8	7.7		
	Connection	mm	100				125			150				200				
Hot Water	Inlet Temp./Outlet Temp.	°C	95 / 80															
	Flow rate	ton/h	7.6	10.1	12.6	15.1	18.9	22.7	27.7	34.0	39.1	45.4	52.9	60.5	68.0	75.6		
		m <sup>3</sup> /h	7.9	10.5	13.1	15.7	19.6	23.6	28.8	35.4	40.6	47.2	55.0	62.9	70.7	78.6		
	Pressure Drop	Shell	mH <sub>2</sub> O	0.2	0.4	0.6	0.8	0.3	0.4	0.6	0.7	0.7	0.8	1.3	1.3	1.3	1.3	
		Control Valve	mH <sub>2</sub> O	2.4	3.0	1.8	2.6	4.0	2.3	3.5	2.1	2.7	3.7	2.0	2.6	3.3	4.0	
	Connection	mm	50				65			80				100				
Control Valve	mm	40		50			65		80			100						
Electric	Power source	-	3PH 400V, 50Hz															
	Abs. Pumps	kW(A)	1.4(5.2)				1.6(5.1)			1.6(5.3)		1.9(6.2)		1.9(6.3)		2.4(8.0)		
	Ref. Pump	kW(A)	0.2(1.1)						0.3(1.4)				0.4(1.4)					
	Purge Pump	kW(A)	0.4 ( 1.4 )															
	Control Panel	kW(A)	0.2 ( 0.5 )															
	Total kW	kW	2.2				2.4			2.5		2.8		2.9		3.4		
	Total Ampere @400V	A	8.2				8.1			8.6		9.5		9.6		11.3		
Size	Length (L)	mm	2,095		2,600			2,634		3,680		3,728		4,748		4,788		
	Width (W)	mm	1,062		1,095			1,229				1,472				1,480		
	Height (H)	mm	1,880				2,255				2,257				2,540			
Weight	Rigging	ton	2.1	2.2	2.6	2.7	3.6	3.7	4.6	4.8	5.5	5.8	6.8	7.1	8.8	9.2		
	Operation	ton	2.3	2.5	2.9	3.1	4.1	4.2	5.2	5.5	6.4	6.8	7.9	8.4	10.4	10.9		
Space for Tube Replacement		mm	1,900			2,400				3,400				4,600				
Water Volume of Machine	Chilled Water Side	ℓ	49	56	66	69	106	116	138	153	210	225	253	274	316	337		
	Cooling Water Side	ℓ	140	162	188	198	313	345	433	480	644	698	715	787	915	993		
	Hot Water Side	ℓ	51	62	71	79	98	107	127	142	170	189	214	239	278	303		

### Note

- Working pressure of each water side is based on 1.0MPa (150psig)
- Fouling factor 0.0001 m<sup>2</sup>.hr.°C/Kcal for Absorber, Condenser and Evaporator.
- Min. outlet temp. of chilled water: 5°C
- Min. allowable inlet temp. of cooling water: 20°C.
- Controllable range shall be 0~100%.
- Standard Power source is 3ph, 400V, 50Hz and available 220, 380, 440V and 460V power source.
- Each water flow can be adjusted within 50~120%.



# LH Series

## Single Effect Hot Water Driven Absorption Chiller

### Performance Data

Model		Unit	L340H	L375H	L420H	L470H	L525H	L600H	L675H	L750H	L825H	L900H	L975H	L1050H	L1125H	L1300H												
Cooling Capacity		kW	1,196	1,319	1,477	1,653	1,846	2,039	2,215	2,637	2,883	3,165	3,428	3,692	3,956	4,571												
		usRT	340	375	420	470	525	580	630	750	820	900	975	1,050	1,125	1,300												
Chilled Water	Inlet Temp./Outlet Temp.	°C	13 / 8																									
	Flow rate	m <sup>3</sup> /h	206	227	254	284	318	351	381	454	496	544	590	635	680	786												
	Pressure Drop	mH <sub>2</sub> O	9.4	9.8	9.5	4.3	5.8	3.4	4.6	6.1	5.5	7.0	8.8	5.2	6.4	9.5												
	Connection	mm	200				250				300				350													
Cooling Water	Inlet Temp./Outlet Temp.	°C	31 / 36.5																									
	Flow rate	m <sup>3</sup> /h	423	466	522	585	653	746	840	933	1,026	1,120	1,213	1,306	1,399	1,617												
	Pressure Drop	mH <sub>2</sub> O	7.5	7.6	6.6	9.0	12.1	4.2	5.6	7.4	6.3	8.1	10.0	6.7	8.2	10.9												
	Connection	mm	250			300			350			400																
Hot Water	Inlet Temp./Outlet Temp.	°C	95 / 80																									
	Flow rate	ton/h	85.7	94.5	106	118	132	151	170	189	208	227	246	265	284	328												
		m <sup>3</sup> /h	89.1	98.2	110	123	138	157	177	196	216	236	255	275	295	341												
	Pressure Drop	Shell	mH <sub>2</sub> O	1.3	1.3	1.4	1.8	2.5	1.6	2.1	2.8	2.1	2.7	3.4	2.8	3.5	5.2											
		Control Valve	mH <sub>2</sub> O	2.0	2.4	3.0	2.4	3.0	2.7	3.2	3.9	1.6	1.8	2.2	2.5	2.9	3.9											
	Connection	mm	125				150				200																	
	Control Valve	mm	125				150				200																	
Electric	Power source	-	3PH 400V, 50Hz																									
	Abs. Pumps	kW(A)	2.4(8.0)		3.7(11.0)			4.2(12.9)			5.2(16.2)			7.5(23.3)														
	Ref. Pump	kW(A)	0.4(1.4)				1.5(4.0)				1.5(4.3)																	
	Purge Pump	kW(A)	0.4(1.4)						0.75(2.2)																			
	Control Panel	kW(A)	0.2 ( 0.5 )																									
	Total kW	kW	3.4		4.7			6.3			7.7			10.0														
	Total Ampere @400V	A	11.3		14.3			18.8			22.9			30.3														
Size	Length (L)	mm	4,876		4,998		5,540		6,038		5,644		6,142		6,667		6,246		6,771		7,271		6,860		7,360		8,360	
	Width (W)	mm	1,597		1,836						2,208				2,379				2,929									
	Height (H)	mm	2,832		3,174						3,600				3,867				4,000									
Weight	Rigging	ton	10.5	10.9	14.7	16.0	17.2	19.3	21.6	23.9	26.2	28.5	30.8	33.1	35.4	40.0												
	Operation	ton	12.5	13.1	17.8	19.4	20.8	23.3	26.1	29.0	31.8	34.6	37.5	40.3	43.2	49.0												
Space for Tube Replacement	mm	4,600			5,200		5,700		5,200		5,700		6,200		5,700		6,200		6,700		6,300		6,800		7,800			
Water Volume of Machine	Chilled Water Side	ℓ	456	479	553	599	642	946	1,008	1,074	1,136	1,241	1,313	1,381	1,767	1,862												
	Cooling Water Side	ℓ	1,291	1,370	1,871	2,006	2,131	2,763	2,932	3,111	3,280	3,735	3,939	4,134	5,741	5,988												
	Hot Water Side	ℓ	334	365	407	448	485	677	729	784	837	806	870	932	1,067	1,138												

### Option

1. Non-standard cooling capacity.
2. Higher working pressure (230psig = 1.6MPa, 300psig = 2.0MPa)
3. Special tubes (material) & thickness.
4. Various temp. conditions (CHW, CW, HW)
5. Outdoor installation.
6. The specifications above are subject to change without prior notice for an improvement of the chiller.

# Single Effect Hot Water Driven Absorption Chiller

**COP**  
**0.827**

## Outline\_Foundation

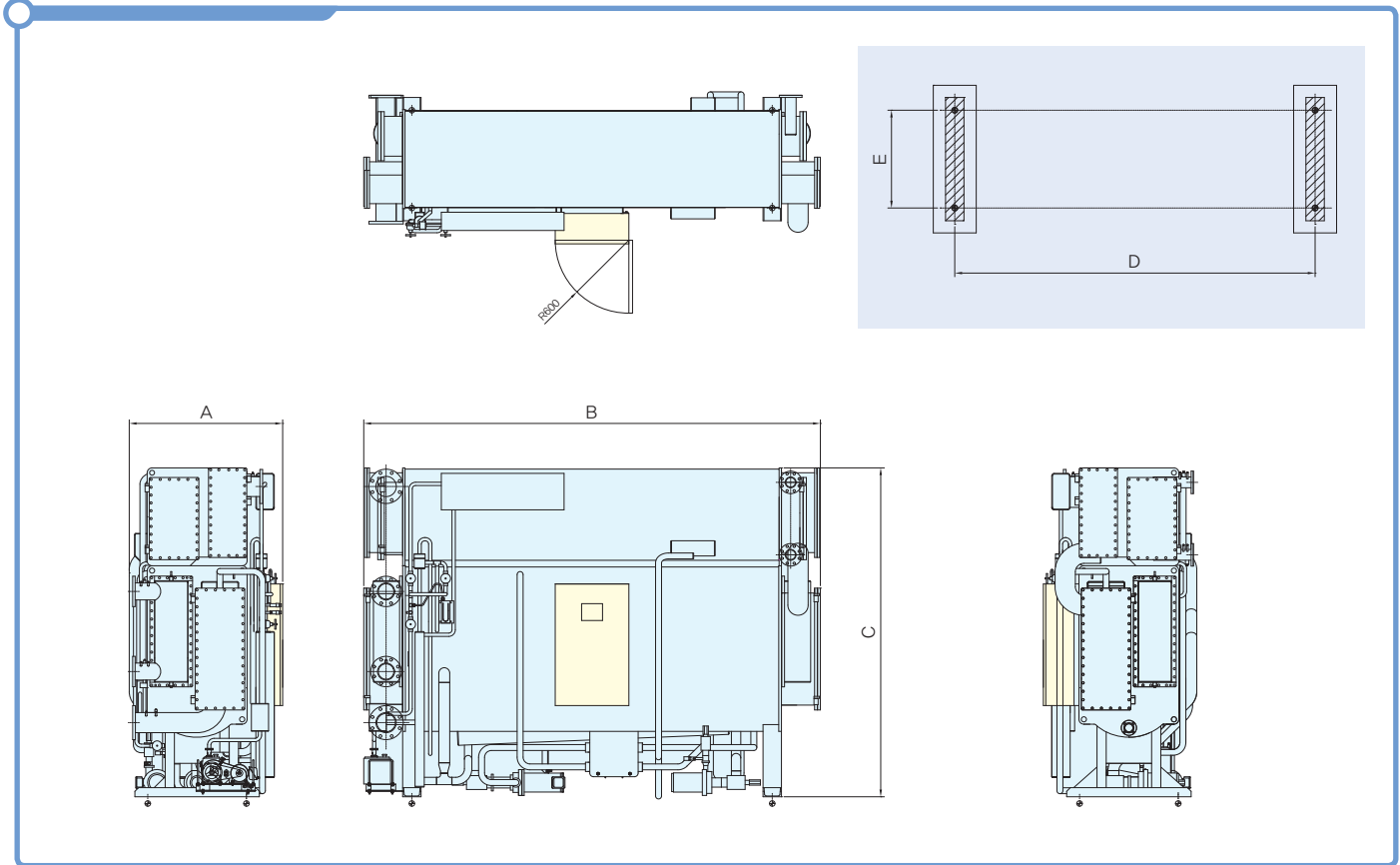

unit : mm

	L30HH	L40HH	L50HH	L60HH	L75HH	L90HH	L110HH	L135HH	L155HH	L180HH	L210HH	L240HH	L270HH	L300HH		
<b>A</b>	2,110		2,610		2,658		3,678		3,728		4,748		4,860			
<b>B</b>	1,156				1,267				1,409				1,451			
<b>C</b>	2,131				2,351				2,660				2,736			
<b>D</b>	1,421		1,941				2,961		2,936		3,956		3,906			
<b>E</b>	640				650				800							
	L340HH	L375HH	L420HH	L470HH	L525HH	L580HH	L630HH	L680HH	L750HH	L820HH	L900H	L975HH	L1050HH	L1125HH	L1300HH	
<b>A</b>	4,872	4,872	5,414	5,912	6,012	6,537	7,037	6,114	6,639	7,139	6,749	7,249	6,966	7,466	8,466	
<b>B</b>	1,588				2,031				2,320				2,479		3,345	
<b>C</b>	2,904				3,118				3,362				3,702		3,709	
<b>D</b>	3,906	3,906	4,448	4,946	4,896	5,421	5,921	4,846	5,371	5,871	5,371	5,871	5,371	5,871	6,871	
<b>E</b>	1,100				1,000				1,400				1,600		2,100	

# LHH Series

## Single Effect Hot Water Driven Absorption Chiller

### Thermal Insulation

1. Use only Non-inflammable or flame retardant insulation materials.
2. Do not insulate motor of refrigerant pump.
3. Total insulation area is including pipings.
4. Do not cover components such as service valves, diaphragm valves, sight glass, control valves, thermometers or sensor.
5. Use the standard insulation material and thickness as the recommendation

6. For the information of insulation area, please refer to the Table below.
7. The water box sections should be worked to be disassembled for the cleaning or repairing.

### Note

#### HOT Surface insulation

- Material of insulation : Inflammable polymer sponge usable at 120°C
- Thickness of insulation : 19mm [3/4 inch], 10mm [3/8 inch] when polymer sponge is used

#### COLD Surface insulation

- Material of insulation : Closed cell type Inflammable polymer sponge
- Thickness of insulation : 19mm [3/4 inch], 10mm [3/8 inch]

Model	Hot Surface(m <sup>2</sup> )		Cold Surface(m <sup>2</sup> )	
	19(mm)	10(mm)	19(mm)	10(mm)
L30HH	3.7	0.9	3.6	0.4
L40HH	3.7	0.9	3.6	0.4
L50HH	4.4	0.9	4.2	0.5
L60HH	4.4	1.0	4.2	0.5
L75HH	4.6	1.1	4.3	0.5
L90HH	4.6	1.1	4.3	0.5
L110HH	6.2	1.2	5.8	0.5
L135HH	6.2	1.3	5.8	0.5
L155HH	6.5	1.6	6.6	0.7
L180HH	6.5	1.7	6.6	0.9
L210HH	8.3	1.8	8.0	0.9
L240HH	8.5	1.9	8.2	0.9
L270HH	9.8	2.1	8.9	0.9
L300HH	9.8	2.1	8.9	0.9

Model	Hot Surface(m <sup>2</sup> )		Cold Surface(m <sup>2</sup> )	
	19(mm)	10(mm)	19(mm)	10(mm)
L340HH	10.9	2.1	10.6	0.9
L375HH	10.9	2.2	10.6	0.9
L420HH	12.2	2.6	14.6	1.1
L470HH	13.5	2.7	16.2	1.2
L525HH	15.0	2.8	17.3	1.2
L580HH	20.3	3.4	17.6	2.1
L630HH	21.9	3.5	19.3	2.1
L750HH	23.7	3.6	21.0	2.1
L820HH	24.2	3.8	21.1	2.3
L900HH	26.0	3.9	22.9	2.3
L975HH	27.6	4.0	27.8	2.3
L1050HH	35.8	5.3	12.4	2.6
L1125HH	37.5	5.4	13.1	2.6
L1300HH	40.6	5.5	14.4	2.6

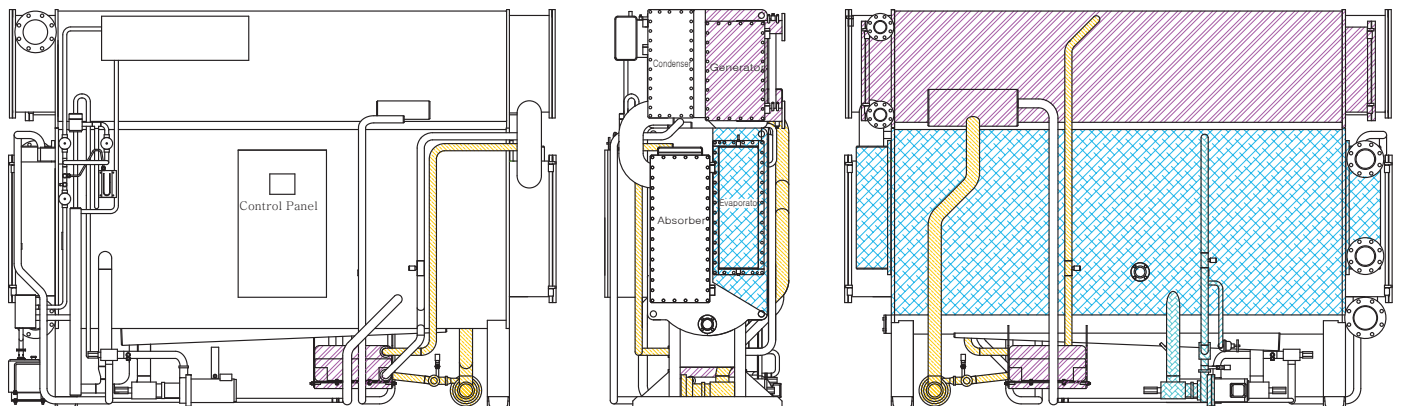

**Hot Surfaces**

- 19mm [3/4 in] : Generator with Water Box
- 10mm [3/8 in] : Heat Exchanger Body with Piping

**Cold Surfaces**

- 19mm [3/4 in] : Evaporator Body with Water Box
- 10mm [3/8 in] : Inlet and Outlet Piping of Refrigerant Pump

# Single Effect Hot Water Driven Absorption Chiller



## Performance Data

→ →

Model		Unit	2ABH30	2ABH40	2ABH50	2ABH60	2ABH75	2ABH90	2ABH110	2ABH135	2ABH155	2ABH180	2ABH210	2ABH240	2ABH270	2ABH300	
Cooling Capacity		kW	105	141	176	211	264	316	387	475	545	633	738	844	949	1,055	
		usRT	30	40	50	60	75	90	110	135	155	180	210	240	270	300	
Chilled Water	Inlet Temp./Outlet Temp.	°C	13 / 8														
	Flow rate	m <sup>3</sup> /h	18.1	24.2	30.2	36.3	45.4	54.4	66.5	81.6	93.7	109	127	145	163	181	
	Pressure Drop	mH <sub>2</sub> O	4.5	5.1	5.9	6.5	6.6	6.7	4.6	4.9	4.5	4.5	9.9	9.7	10.2	10.2	
	Connection	mm	80				100				125				150		
Cooling Water	Inlet Temp./Outlet Temp.	°C	31 / 36.5														
	Flow rate	m <sup>3</sup> /h	40.0	53.3	66.7	80.0	100.0	120	147	180	207	240	280	320	360	400	
	Pressure Drop	mH <sub>2</sub> O	4.5	5.1	9.5	10.4	8.8	9.2	8.5	9.2	6.1	6.1	13.5	13.0	12.8	12.5	
	Connection	mm	100				150				200				250		
Hot Water	Inlet Temp./Outlet Temp.	°C	95 / 55														
	Flow rate	ton/h	3.2	4.3	5.4	6.5	8.1	9.7	11.8	14.5	16.7	19.4	22.6	25.8	29.1	32.3	
		m <sup>3</sup> /h	3.4	4.5	5.6	6.7	8.4	10.1	12.3	15.1	17.4	20.2	23.5	26.9	30.2	33.6	
	Pressure Drop	Shell	mH <sub>2</sub> O	0.6	1.1	1.8	2.3	1.2	1.3	3.3	3.6	3.5	3.6	4.3	4.3	4.8	4.9
		Control Valve	mH <sub>2</sub> O	2.8	2.0	3.1	1.8	2.8	1.6	2.4	2.3	3.0	2.5	3.5	2.9	2.3	2.8
	Connection	mm	50				65				80						
Control Valve	mm	25			32		40		50			65					
Electric	Power source	-	3PH, 400V, 50Hz														
	Abs. Pumps	kW(A)	1.7(6.7)				1.8(6.8)				2.1(7.1)				2.2(7.1)		
	Ref. Pump	kW(A)	0.2(1.2)								0.3(1.4)						
	Purge Pump	kW(A)	0.4(1.4)														
	Control Panel	kW(A)	0.2(0.5)														
	Total kW	kW	2.5				2.6				3.0				3.1		
	Total Ampere @400V	A	9.8				9.9				10.4						
Size	Length (L)	mm	2,292		2,792		2,794		3,750		3,856		4,876		4,960		
	Width (W)	mm	1,500				1,602				1,769				1,966		
	Height (H)	mm	2,252				2,462				2,700				2,845		
Weight	Rigging	ton	4.0	4.1	4.6	4.7	5.4	5.6	6.8	7.1	8.6	8.9	10.2	10.6	12.5	12.8	
	Operation	ton	4.5	4.6	5.2	5.3	6.2	6.4	7.8	8.2	10.0	10.4	11.9	12.5	14.8	15.3	
Space for Tube Replacement		mm	1,900			2,400			3,400			4,600					
Water Volume of Machine	Chilled Water Side	ℓ	60	67	77	80	111	123	142	159	216	237	258	286	324	348	
	Cooling Water Side	ℓ	287	315	354	369	433	469	553	606	803	871	995	1,086	1,358	1,450	
	Hot Water Side	ℓ	126	141	162	172	221	244	282	317	374	414	454	507	621	670	

### Note

- Working pressure of each water side is based on 1.0MPa (150psig)
- Fouling factor 0.0001 m<sup>2</sup>.hr.°C/Kcal for Absorber, Condenser and Evaporator.
- Min. outlet temp. of chilled water: 5°C
- Min. allowable inlet temp. of cooling water: 20°C.
- Controllable range shall be 0~100%.
- Standard Power source is 3ph, 400V, 50Hz and available 220, 380, 440V and 460V power source.
- Each water flow can be adjusted within 50~120%.



# 2ABH Series

## Single Effect Hot Water Driven Absorption Chiller

### Performance Data

Model		Unit	2ABH340	2ABH375	2ABH420	2ABH470	2ABH525	2ABH580	2ABH630	2ABH680	2ABH750	2ABH820	2ABH900	2ABH975	2ABH1050	2ABH1125	2ABH1300			
Cooling Capacity		kW	1,196	1,319	1,477	1,653	1,846	2,039	2,215	2,391	2,637	2,883	3,165	3,428	3,692	3,956	4,571			
		usRT	340	375	420	470	525	580	630	680	750	820	900	975	1,050	1,125	1,300			
Chilled Water	Inlet Temp./Outlet Temp.	°C	13 / 8																	
	Flow rate	m <sup>3</sup> /h	206	227	254	284	318	351	381	411	454	496	544	590	635	680	786			
	Pressure Drop	mH <sub>2</sub> O	9.2	9.7	4.4	5.9	5.6	7.4	9.2	5.5	7.1	9.1	6.9	8.6	5.2	6.4	9.5			
	Connection	mm	200						250			300								
Cooling Water	Inlet Temp./Outlet Temp.	°C	31 / 36.5																	
	Flow rate	m <sup>3</sup> /h	453	500	560	627	700	773	840	906	1,000	1,093	1,200	1,300	1,400	1,500	1,733			
	Pressure Drop	mH <sub>2</sub> O	7.4	7.3	10.0	13.3	8.9	11.5	14.4	9.1	12.2	14.8	11.2	13.9	5.4	6.5	9.6			
	Connection	mm	250				300			350			400		450					
Hot Water	Inlet Temp./Outlet Temp.	°C	95 / 55																	
	Flow rate	ton/h	36.6	40.4	45.2	50.6	56.5	62.5	67.9	73.2	80.8	88.3	96.9	105.0	113.1	121.2	140.0			
		m <sup>3</sup> /h	38.1	42.0	47.0	52.6	58.8	65.0	70.6	76.2	84.0	91.8	100.8	109.2	117.6	126.0	145.6			
	Pressure Drop	Shell	mH <sub>2</sub> O	3.1	3.1	3.0	4.0	4.3	5.5	6.8	3.4	5.0	6.2	5.0	6.2	2.7	3.2	4.7		
		Control Valve	mH <sub>2</sub> O	2.3	2.8	3.5	2.8	3.5	2.7	3.2	2.3	2.8	3.3	4.0	3.0	3.5	2.5	3.4		
	Connection	mm	100						125			150								
Control Valve	mm	80				100			125											
Electric	Power source	-	3PH, 400V, 50Hz																	
	Abs. Pumps	kW(A)	2.8(9.0)			4.2(12.5)			5.7(16.8)			7.5(20.1)			6.3(19.8)					
	Ref. Pump	kW(A)	0.4(1.4)						1.5(4.0)			1.8(6)								
	Purge Pump	kW(A)	0.4(1.4)									0.75 ( 2.2 )								
	Control Panel	kW(A)	0.2(0.5)																	
	Total kW	kW	3.8				5.2			7.8			10.0			9.1				
	Total Ampere @400V	A	12.3				15.8			22.7			26.8			28.5				
Size	Length (L)	mm	5,027		5,569	6,067	6,147	6,672	7,173	6,264	6,790	7,290	6,858	7,358	7,712	8,212	9,212			
	Width (W)	mm	2,233						2,469			2,984			3,359			4,508		
	Height (H)	mm	3,048				3,292			3,553			3,859			4,000				
Weight	Rigging	ton	15.2	15.6	17.1	18.3	23.7	25.7	27.2	33.0	35.4	37.9	43.6	46.3	54.4	57.5	63.2			
	Operation	ton	18.2	18.8	20.5	21.9	28.2	30.5	32.2	39.1	41.9	44.7	52.2	55.2	66.5	70.1	77.0			
Space for Tube Replacement	mm	4,600		5,200	5,700		6,200	6,700	5,700	6,200	6,700	6,200	6,700	6,300	6,800	7,800				
Water Volume of Machine	Chilled Water Side	ℓ	465	485	526	563	656	701	744	944	1,004	1,060	1,355	1,423	1,795	1,890	2,079			
	Cooling Water Side	ℓ	1,755	1,844	1,979	2,102	2,707	2,870	3,026	3,655	3,865	4,066	5,182	5,427	7,684	7,991	8,607			
	Hot Water Side	ℓ	786	844	922	994	1,129	1,211	1,289	1,533	1,642	1,745	2,011	2,140	2,648	2,806	3,120			

### Option

1. Non-standard cooling capacity.
2. Higher working pressure (230psig = 1.6MPa, 300psig = 2.0MPa)
3. Special tubes (material) & thickness.
4. Various temp. conditions (CHW, CW, HW)
5. Outdoor installation.
6. The specifications above are subject to change without prior notice for an improvement of the chiller.

# Single Effect Hot Water Driven Absorption Chiller



## Performance Data

→→

Model		Unit	2AB75	2AB90	2AB110	2AB135	2AB155	2AB180	2AB210	2AB240	2AB270	2AB300	2AB340	2AB375	
Cooling Capacity		kW	264	316	387	475	545	633	738	844	949	1,055	1,196	1,319	
		usRT	75	90	110	135	155	180	210	240	270	300	340	375	
Chilled Water	Inlet Temp./Outlet Temp.	°C	13 / 8												
	Flow rate	m <sup>3</sup> /h	45.4	54.4	66.5	81.6	93.7	109	127	145	163	181	206	227	
	Pressure Drop	mH <sub>2</sub> O	3.7	3.8	10.0	10.5	9.4	10.1	9.6	10.0	10.2	10.5	9.3	9.7	
	Connection	mm	80		100			125			150		200		
Cooling Water	Inlet Temp./Outlet Temp.	°C	31 / 36.5												
	Flow rate	m <sup>3</sup> /h	106	128	156	191	220	255	298	340	383	425	482	531	
	Pressure Drop	mH <sub>2</sub> O	7.6	8.1	5.2	5.8	5.9	6.3	11.4	11.3	10.8	10.6	11.0	11.3	
	Connection	mm	125			150			200			250			
Hot Water	Inlet Temp./Outlet Temp.	°C	95 / 55												
	Flow rate	ton/h	8.9	10.6	13.0	15.9	18.3	21.3	24.8	28.3	31.9	35.4	40.2	44.3	
		m <sup>3</sup> /h	9.2	11.1	13.5	16.6	19.0	22.1	25.8	29.5	33.2	36.8	41.8	46.1	
	Pressure Drop	Shell	mH <sub>2</sub> O	1.0	1.2	2.8	3.4	3.0	3.2	6.4	6.7	6.1	6.1	6.0	6.0
		Control Valve	mH <sub>2</sub> O	2.2	3.2	4.7	2.9	3.8	5.1	2.7	3.6	4.5	2.2	2.8	3.4
	Connection	mm	65				80				100				
Control Valve	mm	40			50			65			80				
Electric	Power source	-	3PH, 400V, 50Hz												
	Abs. Pumps	kW(A)	2.3 (7.7)		2.3 (8.3)		2.6 (9.1)		2.6 (9.2)		3.2 (11)				
	Ref. Pump	kW(A)	0.2 (1.1)		0.3 (1.4)				0.4 (1.4)						
	Purge Pump	kW(A)	0.4 (1.4)												
	Control Panel	kW(A)	0.2 (0.5)												
	Total kW	kW	3.1		3.2		3.5		3.6		4.2				
	Total Ampere @400V	A	10.7		11.6		12.4		12.5		14.3				
Size	Length (L)	mm	2,658		3,678		3,728		4,748		4,872		4,882		
	Width (W)	mm	1,834				2,109				2,248		2,430		
	Height (H)	mm	2,084				2,257				2,519		2,787		
Weight	Rigging	ton	4.4	4.6	5.7	6.0	7.2	7.5	8.8	9.2	11.3	11.8	13.5	14.0	
	Operation	ton	5.1	5.3	6.6	7.0	8.4	8.9	10.4	10.9	13.4	14.1	16.2	16.9	
Space for Tube Replacement	mm	2,400			3,400				4,600						
Water Volume of Machine	Chilled Water Side	ℓ	105	117	136	154	210	225	253	274	316	337	456	479	
	Cooling Water Side	ℓ	425	466	549	610	779	853	911	1,009	1,353	1,461	1,730	1,827	
	Hot Water Side	ℓ	212	230	273	300	367	401	444	490	600	651	772	830	

### Note

- Working pressure of each water side is based on 1.0MPa (150psig)
- Fouling factor 0.0001 m<sup>2</sup>.hr.°C/Kcal for Absorber, Condenser and Evaporator.
- Min. outlet temp. of chilled water: 5°C
- Min. allowable inlet temp. of cooling water: 20°C.
- Controllable range shall be 0~100%.
- Standard Power source is 3ph, 400V, 50Hz and available 220, 380, 440V and 460V power source.
- Each water flow can be adjusted within 50~120%.

# 2AB Series

## Single Effect Hot Water Driven Absorption Chiller

### Performance Data

Model		Unit	2AB420	2AB470	2AB525	2AB600	2AB675	2AB750	2AB825	2AB900	2AB975	2AB1050	2AB1125	2AB1300	
Cooling Capacity		kW	1,477	1,653	1,846	2,110	2,373	2,637	2,901	3,165	3,428	3,692	3,956	4,571	
		usRT	420	470	525	600	675	750	825	900	975	1,050	1,125	1,300	
Chilled Water	Inlet Temp./Outlet Temp.	°C	13 / 8												
	Flow rate	m <sup>3</sup> /h	254	284	318	363	408	454	499	544	590	635	680	786	
	Pressure Drop	mH <sub>2</sub> O	9.4	12.8	5.7	4.1	5.5	7.2	5.4	6.9	8.6	5.2	6.3	9.4	
	Connection	mm	200			250			300						
Cooling Water	Inlet Temp./Outlet Temp.	°C	31 / 36.5												
	Flow rate	m <sup>3</sup> /h	595	666	744	850	956	1,063	1,169	1,275	1,382	1,488	1,594	1,842	
	Pressure Drop	mH <sub>2</sub> O	4.2	5.8	7.7	5.8	7.8	10.2	7.7	9.9	11.6	3.2	3.9	5.3	
	Connection	mm	300			350			400			450			
Hot Water	Inlet Temp./Outlet Temp.	°C	95 / 55												
	Flow rate	ton/h	49.6	55.5	62.0	70.9	79.7	88.6	97.4	106	115	124	133	154	
		m <sup>3</sup> /h	51.6	57.7	64.5	73.7	82.9	92.1	101	111	120	129	138	160	
	Pressure Drop	Shell	mH <sub>2</sub> O	5.4	7.3	6.6	4.4	2.6	3.3	2.9	3.6	4.4	3.0	3.6	5.2
		Control Valve	mH <sub>2</sub> O	1.8	2.2	2.7	3.6	4.5	2.2	2.6	3.2	3.7	4.3	2.0	2.7
	Connection	mm	100			125						150			
Control Valve	mm	100						125			150				
Electric	Power source	-	3PH, 400V, 50Hz												
	Abs. Pumps	kW(A)	5.6 (16.8)			7.7 (23.4)			9.4 (29.1)			12.7 (39.2)			
	Ref. Pump	kW(A)	0.4 (1.4)			1.5 (4.0)						1.5 (4.3)			
	Purge Pump	kW(A)	0.4 (1.4)						0.75 (2.2)						
	Control Panel	kW(A)	0.2 (0.5)												
	Total kW	kW	6.6			9.8			11.9			15.2			
	Total Ampere @400V	A	20.1			29.3			35.8			46.2			
Size	Length (L)	mm	4,992	5,534	6,032	5,637	6,135	6,660	6,246	6,771	7,271	7,010	7,510	8,510	
	Width (W)	mm	2,788			3,140			3,531			4,430			
	Height (H)	mm	3,036			3,471			3,837			4,000			
Weight	Rigging	ton	19.0	20.7	22.2	26.7	28.7	30.7	36.4	38.4	40.8	43.4	46.1	53.1	
	Operation	ton	23.0	25.0	26.9	31.6	34.0	36.3	43.1	45.5	48.3	52.5	55.7	64.1	
Space for Tube Replacement	mm	4,600	5,200	5,700	5,200	5,700	6,200	5,700	6,200	6,700	6,300	6,800	7,800		
Water Volume of Machine	Chilled Water Side	ℓ	553	599	642	873	928	987	1,241	1,313	1,381	1,767	1,862	2,052	
	Cooling Water Side	ℓ	2,448	2,626	2,789	3,567	3,776	3,997	4,938	5,206	5,462	7,868	8,193	8,845	
	Hot Water Side	ℓ	901	984	1,060	1,340	1,439	1,543	1,735	1,865	1,989	2,409	2,558	2,856	

### Option

1. Non-standard cooling capacity.
2. Higher working pressure (230psig = 1.6MPa, 300psig = 2.0MPa)
3. Special tubes (material) & thickness.
4. Various temp. conditions (CHW, CW, HW)
5. Outdoor installation.
6. The specifications above are subject to change without prior notice for an improvement of the chiller.

# Single Effect Hot Water Driven Absorption Chiller



## Thermal Insulation

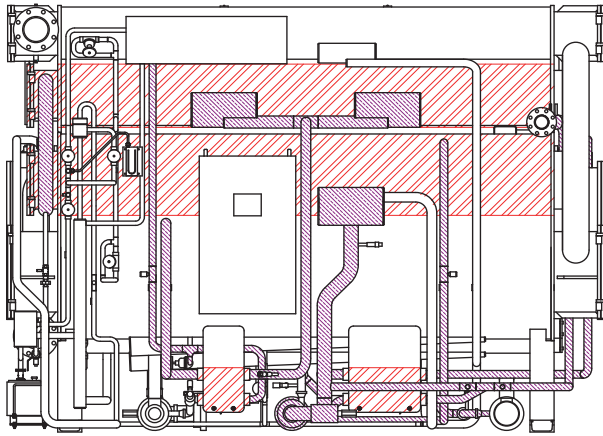

- Hot Surface**
- 19mm : 1<sup>st</sup> Generator with water box, 2<sup>nd</sup> Generator with water box, Aux. Generator with water box, Heat Exchanger body
  - 10mm : Pipes of High temperature's parts
- Cold Surface**
- 19mm : Evaporator with water box
  - 10mm : Inlet and outlet pipes of refrigerant pump

### Note

1. Use only Non-inflammable or flame retardants insulatio materials.
2. Do not insulate motor of refrigerant pump.
3. Total insulation area is including pipings.
4. Do not cover components such as service valves, diaphragm valves, sight glass, control valves, thermometers or sensor.
5. Use the standard insulation material and thickness as the recommendation.

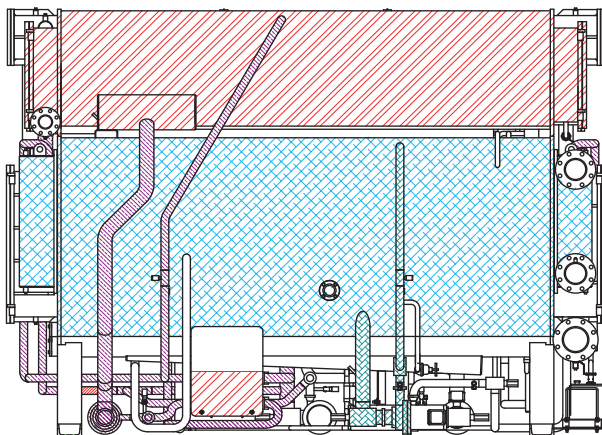
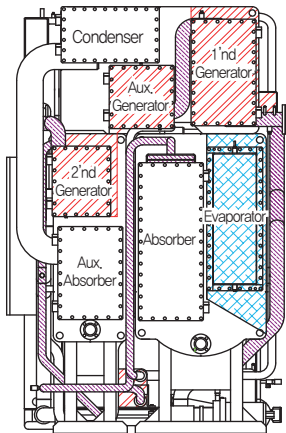

### HOT Surface insulation

- Material of insulation : Inflammable polymer sponge usable at 120°C
- Thickness of insulation : 19mm (3/4 inch), 10mm (3/8 inch) when polymer sponge is used

### COLD Surface insulation

- Material of insulation : Closed cell type Non-inflammable polymer sponge
- Thickness of insulation : 19mm (3/4 inch), 10mm (3/8 inch)

Model \ Thickness (mm)	Hot Surface(m <sup>2</sup> )		Cold Surface(m <sup>2</sup> )	
	19	10	19	10
2ABH30	6.8	4.9	3.5	0.6
2ABH40	6.8	4.9	3.5	0.6
2ABH50	8.1	4.9	4.1	0.7
2ABH60	8.1	5.5	4.1	0.7
2ABH75	8.5	6	4.2	0.7
2ABH90	8.5	6	4.2	0.7
2ABH110	11.4	6	5.7	0.7
2ABH135	11.4	6	5.7	0.7
2ABH155	13.1	6.4	6.2	0.9
2ABH180	13.1	6.4	6.2	0.9
2ABH210	16.6	6.8	7.8	1.0
2ABH240	16.6	6.8	7.8	1.0
2ABH270	18.6	9	8.6	1.1
2ABH300	18.6	9	8.6	1.1
2ABH340	21.7	10.6	10.3	1.1
2ABH375	21.7	10.6	10.3	1.1
2ABH420	25.2	12.5	14.2	1.3
2ABH470	27.4	12.5	15.8	1.4
2ABH525	29.5	12.5	16.9	1.4
2ABH580	32.9	14.7	17.2	2.3
2ABH630	35.1	14.7	18.8	2.3
2ABH680	33.7	14.7	20.2	2.3
2ABH750	37.2	14.7	20.4	2.3
2ABH820	40.7	1.6	20.6	2.5
2ABH900	42.9	1.6	22.3	2.5
2ABH975	45	1.6	27.1	2.5
2ABH1050	47.2	16.9	28.5	2.7
2ABH1125	49.6	16.9	29.9	2.7
2ABH1300	52.1	16.9	31.4	2.7



# 2ABH Series

## Single Effect 2-Lift Hot water Driven Absorption Chiller

### System Piping

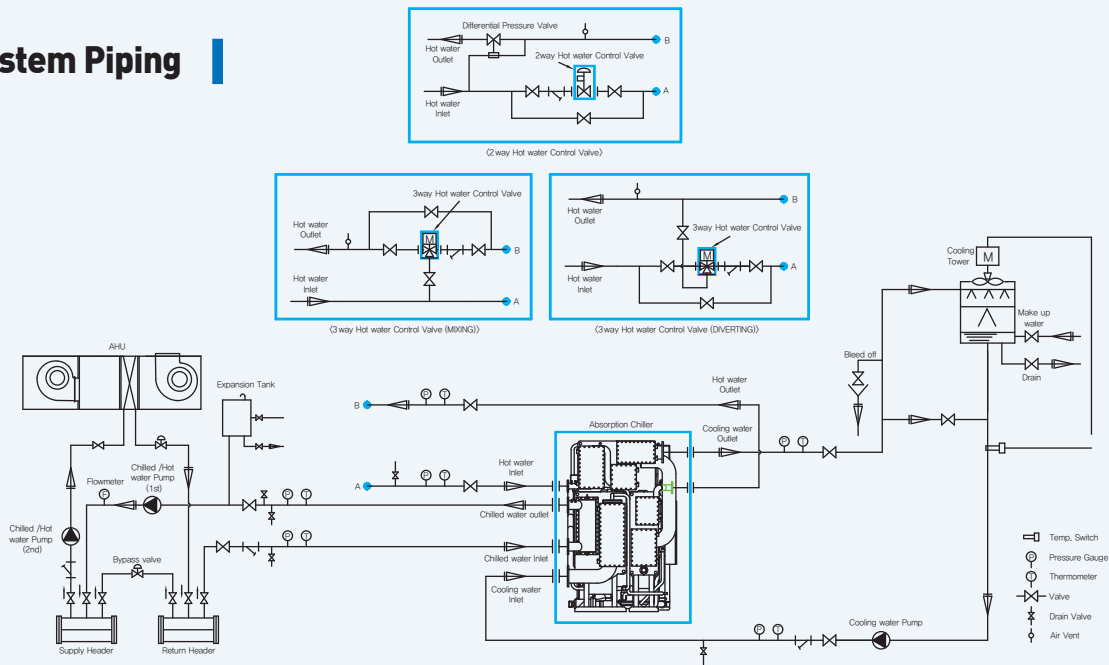

- 1) All external equipment out of the blue line is the customer's scope.
- 2) Refer to outline drawing and specification data sheet to figure out the external dimensions of the machine, the location & the diameter of water pipe connection and etc.
- 3) Driving hot water must be maintained as the designed temperature.
- 4) It is strongly recommended to install shut-off valves at hot water inlet and outlet pipe.
- 5) The locations of chilled water pumps, cooling water pumps and expansion tanks shall be determined in consideration of the hydrostatic head of pumps and the height of building. And the Machine shall not be subjected to a pressure higher than the designed pressure at any water header.
- 6) For cooling water quality control, it is recommended to install cooling water bleed-off device on the inlet pipe line of cooling towers.

- 7) Around 10 meshes of strainers are recommended to be installed in the cooling water line.
- 8) For the maintenance and the inspection of the machine, the following equipments shall be installed on each chilled water and cooling water inlet/outlet lines as well as stop valve.
  - Thermometers and pressure gauges shall be installed at chilled and cooling water inlet/outlet.
  - Air relief valves shall be installed on each chilled and cooling water lines at higher points than each water header.
  - Drain valves shall be installed at the lowest position between the shut off valves of chilled and cooling water and the Machine and the drain valve shall be piped to the drain ditch.
- 9) There shall be a sufficient clearance for access to the absorber, evaporator, condenser, and generator to facilitate inspection and cleaning work.

### Advantage of 2ABH Series

- \* 14% Less operational cost
- \* 20% Less foot print
- \* 8% Smaller sized Cooling water pump & Cooling tower
- \* Higher COP at Full load & Part load

	CW In (°C)	Cooling Capacity(%)	HW out (°C)	Aux. cycle Operation	COP	Part Load rate	IPLV
2ABH	31.0	100%	55.0	ON	0.71	0.01	0.91
	29.8	75%	48.3	OFF	0.85	0.42	
	28.8	50%	43.0	OFF	0.86	0.45	
2AB	28.0	25%	38.3	OFF	0.89	0.12	0.83
	31.0	100%	55.0	ON	0.64	0.01	
	29.8	75%	47.9	OFF	0.83	0.42	
	28.8	50%	42.8	OFF	0.83	0.45	
	28.0	25%	38.5	OFF	0.81	0.12	

- 1) CHW Outlet is maintained as 8°C and HW inlet as 95°C
- 2) WB temperature : 27°C
- 3) Part load rate is according to ARI560-222

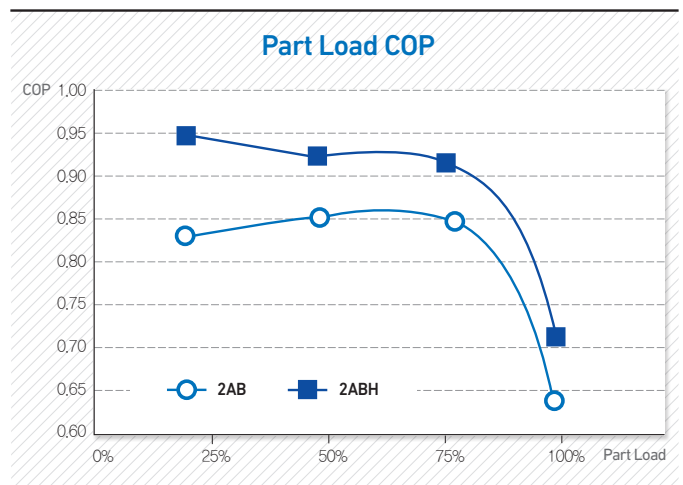

# Single Effect Hot Water Driven Absorption Chiller



## Performance Data

→ →

Model		Unit	2AA30	2AA40	2AA50	2AA60	2AA75	2AA90	2AA110	2AA135	2AA155	2AA180	2AA210	2AA240	2AA270	2AA300				
Cooling Capacity		kW	105	141	176	211	264	316	387	475	545	633	738	844	949	1,055				
		usRT	30	40	50	60	75	90	110	135	155	180	210	240	270	300				
Chilled Water	Inlet Temp./Outlet Temp.	°C	13 / 8																	
	Flow rate	m <sup>3</sup> /h	18.1	24.2	30.2	36.3	45.4	54.4	66.5	81.6	93.7	109	127	145	163	181				
	Pressure Drop	mH <sub>2</sub> O	4.5	5.1	5.9	6.5	6.6	6.7	4.6	4.9	4.5	4.5	9.9	9.7	10.2	10.2				
	Connection	mm	80				100				125				150					
Cooling Water	Inlet Temp./Outlet Temp.	°C	31 / 36																	
	Flow rate	m <sup>3</sup> /h	62.2	82.9	104	124	155	187	228	280	321	373	435	497	560	622				
	Pressure Drop	mH <sub>2</sub> O	4.6	5.1	5.3	5.9	4.9	5.2	3.5	3.8	7.3	7.2	7.5	7.2	7.5	7.4				
	Connection	mm	125				200				250									
Hot Water	Inlet Temp./Outlet Temp.	°C	70 / 60																	
	Flow rate	ton/h	22.0	29.4	36.7	44.0	55.1	66.1	80.7	99.1	114	132	154	176	198	220				
		m <sup>3</sup> /h	22.5	30.0	37.6	45.1	56.3	67.6	82.6	101	116	135	158	180	203	225				
	Pressure Drop	Shell	mH <sub>2</sub> O	4.0	4.3	3.4	4.0	2.5	2.5	3.3	3.6	3.5	3.8	2.8	3.1	2.5	2.5			
		Control Valve	mH <sub>2</sub> O	2.0	3.6	3.6	3.2	3.2	4.6	2.7	4.0	3.4	4.6	2.5	3.3	4.1	3.2			
	Connection	mm	80				125				150				200					
Control Valve	mm	65		80		100				125				150		200				
Electric	Power source	-	3PH, 400V, 50Hz																	
	Abs. Pumps	kW(A)	0.6(2.8)				0.8(2.8)				3.0(8.6)									
	Ref. Pump	kW(A)	0.2 ( 1.2 )						0.3 ( 1.4 )											
	Purge Pump	kW(A)	0.4 ( 1.4 )																	
	Control Panel	kW(A)	0.2 ( 0.5 )																	
	Total kW	kW	1.4				1.6				1.7				3.9					
	Total Ampere @400V	A	5.9						6.1						11.9					
Size	Length (L)	mm	2,340		2,840		2,972		3,992		4,129		5,149		5,266					
	Width (W)	mm	1,729				1,801				1,887				2,080		2,168		2,360	
	Height (H)	mm	2,282				2,545				2,777				2,853					
Weight	Rigging	ton	3.9	4.0	4.4	4.5	5.4	5.6	6.9	7.1	8.7	9.0	10.3	10.8	12.6	13.0				
	Operation	ton	4.5	4.7	5.1	5.1	6.2	6.5	7.9	8.3	10.2	10.6	12.2	12.8	15.2	15.7				
Space for Tube Replacement	mm	1,900			2,400				3,400				4,600							
Water Volume of Machine	Chilled Water Side	ℓ	60	67	77	80	111	123	142	159	216	237	258	286	324	348				
	Cooling Water Side	ℓ	320	345	383	391	408	438	515	561	753	820	924	1,013	1,201	1,269				
	Hot Water Side	ℓ	121	137	158	165	216	237	277	308	368	404	448	495	623	664				

### Note

- Working pressure of each water side is based on 1.0MPa (150psig)
- Fouling factor 0.0001 m<sup>2</sup>.hr.°C/Kcal for Absorber, Condenser and Evaporator.
- Min. outlet temp. of chilled water: 5°C
- Min. allowable inlet temp. of cooling water: 20°C.
- Controllable range shall be 0~100%.

# 2AA Series

## Single Effect 2-Lift Waste Heat Recovery Driven Absorption Chiller

### Performance Data

Model		Unit	2AA340	2AA375	2AA420	2AA470	2AA525	2AA580	2AA630	2AA680	2AA750	2AA820	2AA900	2AA975	2AA1050	2AA1125	2AA1300	
Cooling Capacity		kW	1,196	1,319	1,477	1,653	1,846	2,039	2,215	2,391	2,637	2,883	3,165	3,428	3,692	3,956	4,571	
		usRT	340	375	420	470	525	580	630	680	750	820	900	975	1,050	1,125	1,300	
Chilled Water	Inlet Temp./Outlet Temp.	°C	13 / 8															
	Flow rate	m <sup>3</sup> /h	206	227	254	284	318	351	381	411	454	496	544	590	635	680	786	
	Pressure Drop	mH <sub>2</sub> O	9.2	9.7	4.4	5.9	5.6	7.4	9.2	5.5	7.1	9.1	6.9	8.6	5.2	6.4	9.5	
	Connection	mm	200						250			300						
Cooling Water	Inlet Temp./Outlet Temp.	°C	31 / 36															
	Flow rate	m <sup>3</sup> /h	705	777	871	974	1,088	1,202	1,306	1,409	1,555	1,700	1,865	2,021	2,176	2,332	2,695	
	Pressure Drop	mH <sub>2</sub> O	7.5	7.4	5.2	6.9	3.6	4.7	5.8	3.6	4.8	5.9	4.6	5.7	4.5	5.5	8.0	
	Connection	mm	350				400			450			500					
Hot Water	Inlet Temp./Outlet Temp.	°C	70 / 60															
	Flow rate	ton/h	250	275	308	345	385	426	462	499	551	602	661	716	771	826	954	
		m <sup>3</sup> /h	255	282	315	353	394	436	473	511	563	616	676	732	789	845	976	
	Pressure Drop	Shell	mH <sub>2</sub> O	2.8	2.9	3.9	5.2	4.7	6.2	7.7	4.4	5.7	7.2	5.6	6.9	5.2	6.3	9.4
		Control Valve	mH <sub>2</sub> O	4.1	5.0	2.5	3.1	2.4	3.0	3.5	2.6	3.2	3.8	2.9	3.4	2.4	2.8	3.7
	Connection	mm	200				250			300				350				
Control Valve	mm	200					250				300							
Electric	Power source	-	3PH, 400V, 50Hz															
	Abs. Pumps	kW(A)	3.0(8.6)						3.6(12.0)				4.4(13.4)					
	Ref. Pump	kW(A)	0.4 ( 1.4 )						1.5 ( 4.0 )				1.8(6)					
	Purge Pump	kW(A)	0.4 ( 1.4 )									0.75 ( 2.2 )						
	Control Panel	kW(A)	0.2 ( 0.5 )															
	Total kW	kW	4.0						5.7			6.1			7.2			
	Total Ampere @400V	A	11.9						17.9				18.7			22.1		
Size	Length (L)	mm	5,368		5,910	6,408	6,633	7,158	7,658	6,841	7,366	7,866	7,378	7,878	7,866	8,166	9,166	
	Width (W)	mm	2,718		2,815		2,995	3,072		3,657		3,746	4,150		5,052			
	Height (H)	mm	3,019				3,240			3,546			3,929			4,000		
Weight	Rigging	ton	15.4	15.9	17.4	18.6	24.0	26.1	27.6	33.5	35.9	38.5	44.3	47.0	55.4	58.5	64.5	
	Operation	ton	18.7	19.3	21.2	22.7	28.9	31.4	33.1	40.3	43.1	46.1	53.8	57.0	68.1	71.9	79.1	
Space for Tube Replacement	mm	4,600		5,200	5,700		6,200	6,700	5,700	6,200	6,700	6,200	6,700	6,300	6,800	7,800		
Water Volume of Machine	Chilled Water Side	ℓ	465	485	526	563	656	701	744	944	1,004	1,060	1,355	1,423	1,795	1,890	2,079	
	Cooling Water Side	ℓ	1,696	1,780	1,909	2,027	2,405	2,545	2,678	3,127	3,308	3,481	4,376	4,586	6,112	6,390	6,946	
	Hot Water Side	ℓ	762	812	889	959	1,127	1,207	1,284	1,562	1,674	1,781	2,073	2,205	2,708	2,868	3,188	

### Option

1. Non-standard cooling capacity.
2. Higher working pressure (230psig = 1.6MPa, 300psig = 2.0MPa)
3. Special tubes (material) & thickness.
4. Various temp. conditions (CHW, CW, HW)
5. Outdoor installation.

# Double Effect Direct Fired Absorption Chiller & Heater

## DWHH Series

### • Cooling Cycle

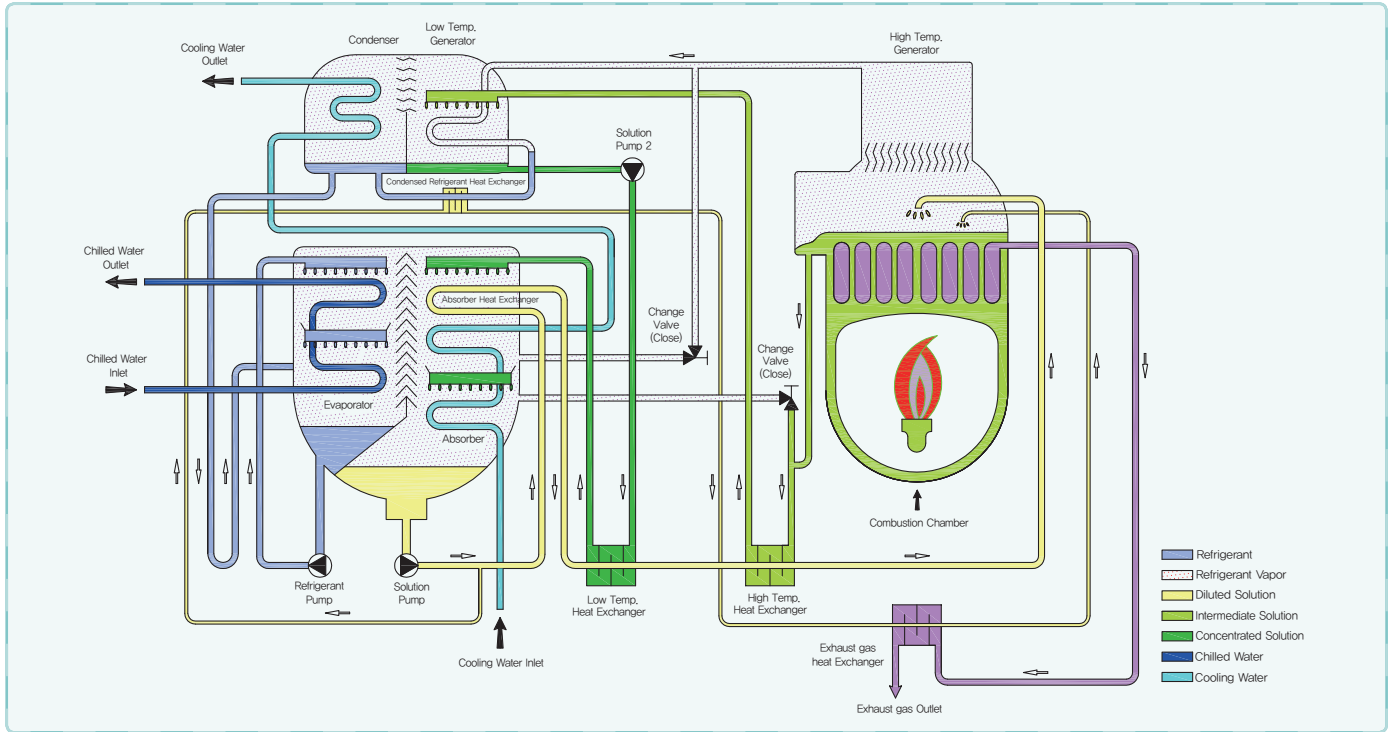

### • Heating Cycle

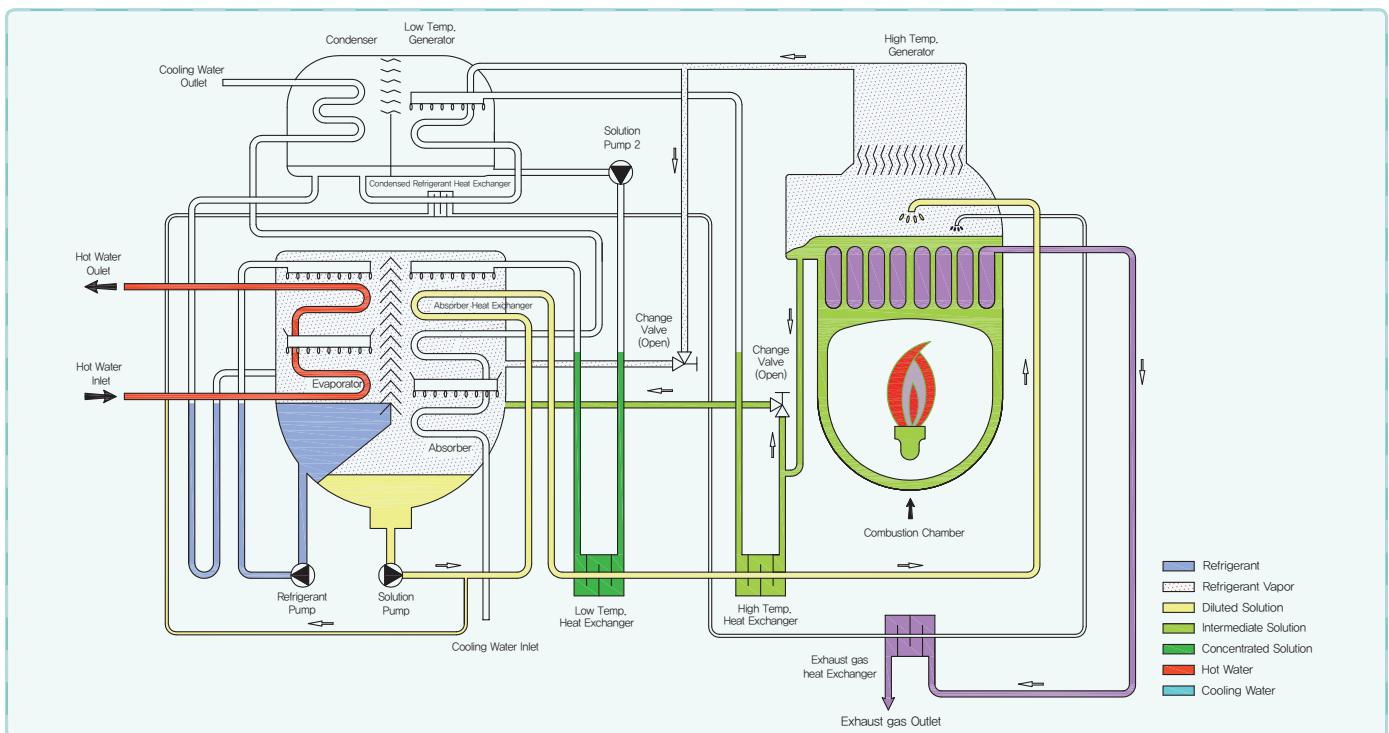



**DW Series**

• **Cooling Cycle**

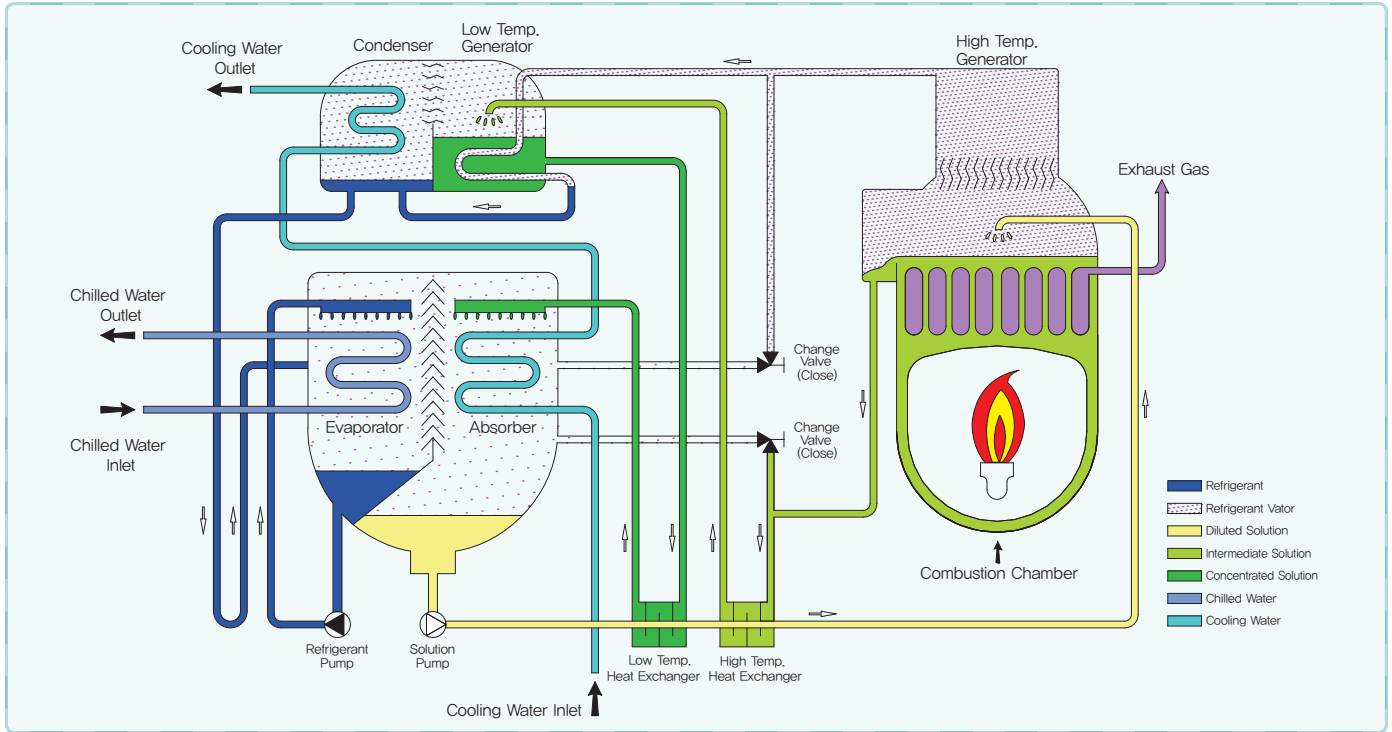

• **Heating Cycle**

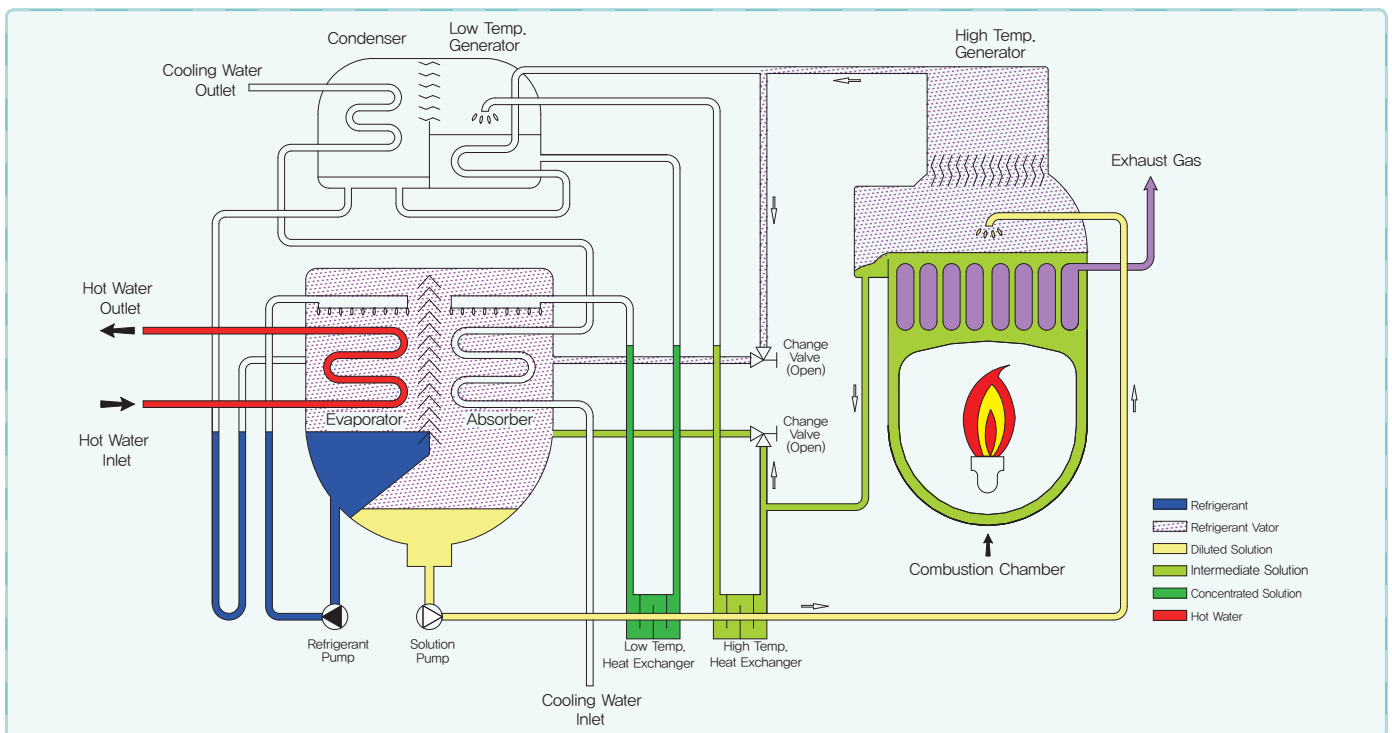

# Double Effect Direct Fired Absorption Chiller & Heater



## Performance Data



Model		Unit	DWHH50	DWHH60	DWHH70	DWHH80	DWHH100	DWHH120	DWHH150	DWHH180	DWHH210	DWHH240	DWHH280	DWHH320	DWHH360	
Cooling Capacity	kW		176	211	246	281	352	422	527	633	738	844	985	1,125	1,266	
	usRT		50	60	70	80	100	120	150	180	210	240	280	320	360	
Heating Capacity	kW		116	139	162	185	232	278	348	417	487	556	649	742	834	
	Mcal/h		100	120	140	159	199	239	299	359	419	478	558	638	718	
Chilled Water	Inlet/Outlet Temp.	°C	12 / 7													
	Flow rate	m <sup>3</sup> /h	30.2	36.3	42.3	48.4	60.5	72.6	90.7	108.9	127.0	145.2	169.3	193.5	217.7	
	Pressure Drop	mH <sub>2</sub> O	7.5	6.9	6.3	6.9	5.9	6.1	8.0	8.2	7.6	7.5	5.4	5.3	5.7	
	Connection	mm	80				100				125			150		
Hot Water	Inlet/Outlet Temp.	°C	56.8 / 60													
	Flow rate	m <sup>3</sup> /h	30.2	36.3	42.3	48.4	60.5	72.6	90.7	108.9	127.0	145.2	169.3	193.5	217.7	
	Pressure Drop	mH <sub>2</sub> O	7.5	6.9	6.3	6.9	5.9	6.1	8.0	8.2	7.6	7.5	5.4	5.3	5.7	
	Connection	mm	80				100				125			150		
Cooling Water	Inlet/Outlet Temp.	°C	32 / 37.1													
	Flow rate	m <sup>3</sup> /h	50	60	70	80	100	120	150	180	210	240	280	320	360	
	Pressure Drop	mH <sub>2</sub> O	7.3	6.1	8.0	7.6	7.3	7.7	9.9	10.4	11.5	10.2	8.3	7.9	8.1	
	Connection	mm	100				125			150				200		
Gas	High Heating Value	kcal/Nm <sup>3</sup>	10,400													
	Flow rate	Nm <sup>3</sup> /h	11.0	13.2	15.4	17.6	22.0	26.4	33.0	39.7	46.3	52.9	61.7	70	79	
	Inlet Pressure	mmAq	200				4000									
	Connection	mm	50 (200mmAq)				40 (4000mmAq)					50 (4000mmAq)				
	Exhaust gas	mm	190x110	270x150			232x400				290x600			360x310		
Electric	Power source	-	3PH, 400V, 50Hz													
	Ref. Pump	kW	0.2(1.2)								0.3(1.4)					
	Abs. Pump1	kW	1.2(3.8)				1.5(4.8)				2.0(5.7)			2.4(6.7)		
	Purge Pump	kW	0.4(1.4)													
	Burner	kW	0.37(1.4)		0.74(1.7)			1.5(4.6)				2.2(6.0)			5.5(13.0)	
	Control Panel	kW	0.2(0.5)													
	Total kW	kW	2.4		2.7		3.0		3.8			4.4		5.1		8.8
	Total Ampere @400V	A	8.3		8.6		9.6		12.5			13.6		17.3		23.0
Size	Length (L)	mm	2,245	2,971				3,804			3,869		4,919		5,077	
	Width (W)	mm	1,477		1,833			1,697		1,792			1,902			2,200
	Height (H)	mm	1,901		1,997			2,202				2,460				2,557
Weight	Rigging	ton	2.7	2.9	3.4	3.6	4.5	4.8	5.7	6.2	7.2	7.6	8.8	9.3	11.5	
	Operation	ton	2.9	3.1	3.7	3.9	5.0	5.3	6.3	6.8	8.0	8.5	9.8	10.4	12.8	
Space for Tube Replacement	mm	1,900			2,400				3,400				4,600			

### Note

- Working pressure of each water side is based on 1.0MPa (150psig)
- Fouling factor 0.0001 m<sup>2</sup>.hr. °C/Kcal for Absorber, Condenser and Evaporator.
- Min. outlet temp. of chilled water: 5°C
- Min. allowable inlet temp. of cooling water: 20°C.
- Controllable range shall be 25~100%.
- Standard Power source is 3ph, 400V, 50Hz and available 220, 380, 440V and 460V power source.
- Each water flow can be adjusted within 50~120%.

# DWHH Series

## Double Effect Direct Fired Absorption chiller & Heater

### Performance Data

Model		Unit	DWHH400	DWHH450	DWHH500	DWHH560	DWHH630	DWHH700	DWHH770	DWHH840	DWHH900	DWHH1000	DWHH1100	DWHH1200	DWHH1300	DWHH1400	DWHH1500												
Cooling Capacity	kW	1,407	1,582	1,758	1,969	2,215	2,461	2,708	2,954	3,165	3,516	3,868	4,220	4,571	4,923	5,274													
	usRT	400	450	500	560	630	700	770	840	900	1,000	1,100	1,200	1,300	1,400	1,500													
Heating Capacity	kW	927	1,043	1,159	1,298	1,460	1,622	1,785	1,947	2,086	2,318	2,549	2,781	3,013	3,245	3,476													
	Mcal/h	797	897	997	1,116	1,256	1,395	1,535	1,674	1,794	1,993	2,192	2,392	2,591	2,790	2,990													
Chilled Water	Inlet/Outlet Temp.	°C	12/7																										
	Flow rate	m <sup>3</sup> /h	241.9	272.2	302.4	338.7	381.0	423.4	465.7	508.0	544.3	604.8	665.3	725.8	786.2	846.7	907.2												
	Pressure Drop	mH <sub>2</sub> O	5.8	5.0	5.3	7.3	9.9	9.4	12.0	15.1	17.0	11.9	15.1	11.4	14.3	8.6	10.6												
	Connection	mm	150	200				250				300			350														
Hot Water	Inlet/Outlet Temp.	°C	56.8 / 60																										
	Flow rate	m <sup>3</sup> /h	241.9	272.2	302.4	338.7	381.0	423.4	465.7	508.0	544.3	604.8	665.3	725.8	786.2	846.7	907.2												
	Pressure Drop	mH <sub>2</sub> O	5.8	5.0	5.3	7.3	9.9	9.4	12.0	15.1	17.0	11.9	15.1	11.4	14.3	8.6	10.6												
	Connection	mm	150	200				250				300			350														
Cooling Water	Inlet/Outlet Temp.	°C	32 / 37.1																										
	Flow rate	m <sup>3</sup> /h	400	450	500	560	630	700	770	840	900	1,000	1,100	1,200	1,300	1,400	1,500												
	Pressure Drop	mH <sub>2</sub> O	8.2	8.2	8.3	11.3	15.3	11.9	13.4	14.0	8.8	14.8	15.8	14.1	13.4	13.6	14.1												
	Connection	mm	200	250				300				350			400		450												
Gas	High Heating Value	kcal/Nm <sup>3</sup>	10,400																										
	Flow rate	Nm <sup>3</sup> /h	88	99	110	123	139	154	170	185	198	220	242	264	286	308	330												
	Inlet Pressure	mmAq	4000																										
	Connection	mm	50 (4000mmAq)									65 (4000mmAq)																	
	Exhaust gas	mm	410x310			412x670			400x620			400x900																	
Electric	Power source	-	3PH, 400V, 50Hz																										
	Ref. Pump	kW	0.3(1.4)	0.4 (1.4)						1.5 (4.0)				1.8(6.0)															
	Abs. Pump1	kW	2.4(6.7)	3.0(8.6)				4.5(12.4)				5.5(14.3)			4.5(15.2)		5.5(19.0)												
	Purge Pump	kW	0.4(1.4)									0.75(2.2)																	
	Burner	kW	5.5(13.0)				7.5(15.8)				11.0(22.0)				15.0(29.3)														
	Control Panel	kW	0.2(0.5)																										
	Total kW	kW	8.8	9.5			11.5		13.0			15.1		18.6		18.0		23.3											
	Total Ampere @400V	A	23.0	24.9			27.7		31.5			36.0		42.2		43.9		50.0											
Size	Length (L)	mm	5077			5,739		6,219		6,231		6,836		7,230		6,230		6,829		7,449		6,920		7,420		7,197		7,697	
	Width (W)	mm	2,200	2,510				2,760		3,281				3,290		3,880				4,420									
	Height (H)	mm	2,557	2,723			2,793			3,020			3,171			3,940			4,000										
Weight	Rigging	ton	12.1	14.1	14.8	19.6	21.2	22.7	25.0	28.7	30.6	32.9	40.4	43.4	46.0	50.1	52.7												
	Operation	ton	13.5	15.8	16.6	22.2	24.0	25.7	28.0	32.0	34.4	37.1	45.1	48.5	51.5	56.1	59.1												
Space for Tube Replacement	mm	4,600			5,200		5,700		6,300		6,700		6,700		6,300		6,700		6,300		6,700								

### Option

1. Non-standard cooling capacity.
2. Higher working pressure (230psig = 1.6MPa, 300psig = 2.0MPa)
3. Special tubes (material) & thickness.
4. Various temp. conditions (CHW, CW, HW)
5. Outdoor installation.
6. The specifications above are subject to change without prior notice for an improvement of the chiller.

# Double Effect Direct Fired Absorption Chiller & Heater



## Performance Data

→ →

Model		Unit	DWH50	DWH60	DWH70	DWH80	DWH100	DWH120	DWH150	DWH180	DWH210	DWH240	DWH280	DWH320	DWH360	DWH400									
Cooling Capacity	kW	176	211	246	281	352	422	527	633	738	844	985	1,125	1,266	1,407										
	usRT	50	60	70	80	100	120	150	180	210	240	280	320	360	400										
Heating Capacity	kW	121	145	170	194	242	291	363	436	509	581	678	775	872	969										
	kcal/h	104	125	146	167	208	250	313	375	438	500	583	667	750	833										
Chilled Water	Inlet/Outlet Temp.	°C	12 / 7																						
	Flow rate	m <sup>3</sup> /h	30.2	36.3	42.3	48.4	60.5	72.6	90.7	108.9	127.0	145.2	169.3	193.5	217.7	241.9									
	Pressure Drop	mH <sub>2</sub> O	4.0	3.7	6.2	6.9	5.6	5.9	7.6	8.1	7.5	7.4	5.4	5.3	5.8	6.0									
	Connection	mm	80				100				125				150										
Hot Water	Inlet/Outlet Temp.	°C	56.3 / 60																						
	Flow rate	m <sup>3</sup> /h	30.2	36.3	42.3	48.4	60.5	72.6	90.7	108.9	127.0	145.2	169.3	193.5	217.7	241.9									
	Pressure Drop	mH <sub>2</sub> O	4.0	3.7	6.2	6.9	5.6	5.9	7.6	8.1	7.5	7.4	5.4	5.3	5.8	6.0									
	Connection	mm	80				100				125				150										
Cooling Water	Inlet/Outlet Temp.	°C	32 / 37.1																						
	Flow rate	m <sup>3</sup> /h	50	60	70	80	100	120	150	180	210	240	280	320	360	400									
	Pressure Drop	mH <sub>2</sub> O	7.0	6.1	10.2	10.0	8.9	9.1	10.4	10.8	10.7	11.2	8.9	8.6	8.8	8.7									
	Connection	m	100				125				150				200										
Gas	High Heating Value	kcal/Nm <sup>3</sup>	10,400																						
	Flow rate	Nm <sup>3</sup> /h	12.1	14.5	17.0	19.4	24.2	29.1	36.3	43.6	50.9	58.2	67.8	77.5	87.2	96.9									
	Inlet Pressure	mmAq	200				4,000																		
	Connection	mm	50(200mmAq)				40(4,000mmAq)				50(4,000mmAq)														
	Exhaust gas	mm	180 x 110		270 x 150		280 x 210				310 x 310				360 x 310										
Electric	Power source	–	3PH, 400V, 50Hz																						
	Ref. Pump	kW	0.2				0.3				0.4														
	Abs. Pump1	kW	1.5				2.0				2.4				3.2										
	Abs. Pump2	kW	0.2				0.3				0.4														
	Purge Pump	kW	0.4																						
	Burner	kW	0.4				0.7		1.1				2.2				4.0								
	Control Panel	kW	0.2																						
	Total kW	kW	2.9				3.9				4.3				4.8				6.0		6.8		8.6		
Total Ampere @400V	A	9.7				13.0				15.2				15.7				17.3				19.4		23.0	
Size	Length (L)	mm	2,095		2,598		2,597		3,680		3,708		4,734		4,776										
	Width (W)	mm	1,477		1,615		1,810		1,920		2,117		2,137		2,270										
	Height (H)	mm	1,760				2,090				2,122				2,385										
Weight	Rigging	ton	2.7	2.9	3.4	3.6	4.5	4.8	5.7	6.2	7.2	7.6	8.8	9.3	11.5	12.1									
	Operation	ton	2.9	3.1	3.7	3.9	5.0	5.3	6.3	6.8	8.0	8.5	9.8	10.4	12.8	13.5									
Space for Tube Replacement	mm	1,900		2,400				3,400				4,500													

### Note

- Working pressure of each water side is based on 1.0MPa (150psig)
- Fouling factor 0.0001 m<sup>2</sup>.hr.°C/Kcal for Absorber, Condenser and Evaporator.
- Min. outlet temp. of chilled water: 5°C
- Min. allowable inlet temp. of cooling water: 20°C.
- Controllable range shall be 25~100%.
- Standard Power source is 3ph, 400V, 50Hz and available 220, 380, 440V and 460V power source.
- Each water flow can be adjusted within 50~120%.



# DWH Series

## Double Effect Direct Fired Absorption chiller & Heater

### Performance Data

Model		Unit	DWH450	DWH500	DWH560	DWH630	DWH700	DWH800	DWH900	DWH1000	DWH1100	DWH1200	DWH1300	DWH1400	DWH1500		
Cooling Capacity	kW	1,582	1,758	1,969	2,215	2,461	2,813	3,165	3,516	3,868	4,220	4,571	4,923	5,274			
	usRT	450	500	560	630	700	800	900	1,000	1,100	1,200	1,300	1,400	1,500			
Heating Capacity	kW	1,090	1,211	1,357	1,526	1,696	1,938	2,181	2,423	2,665	2,907	3,510	3,392	3,634			
	kcal/h	937	1,041	1,167	1,312	1,459	1,667	1,876	2,084	2,292	2,500	3,019	2,917	3,125			
Chilled Water	Inlet/Outlet Temp.	°C	12 / 7														
	Flow rate	m³/h	272.2	302.4	338.7	381.0	423.4	483.8	544.3	604.8	665.3	725.8	786.2	846.7	907.2		
	Pressure Drop	mH <sub>2</sub> O	5.1	5.4	4.2	5.8	7.7	5.7	7.7	10.1	6.7	8.6	10.7	8.7	10.6		
	Connection	mm	200				250			300			350				
Hot Water	Inlet/Outlet Temp.	°C	56.3 / 60														
	Flow rate	m³/h	272.2	302.4	338.7	381.0	423.4	483.8	544.3	604.8	665.3	725.8	786.2	846.7	907.2		
	Pressure Drop	mH <sub>2</sub> O	5.1	5.4	4.2	5.8	7.7	5.7	7.7	10.1	6.7	8.6	10.7	8.7	10.6		
	Connection	mm	200				250			300			350				
Cooling Water	Inlet/Outlet Temp.	°C	32 / 37.1														
	Flow rate	m³/h	450	500	560	630	700	800	900	1,000	1,100	1,200	1,300	1,400	1,500		
	Pressure Drop	mH <sub>2</sub> O	8.4	8.6	6.8	9.3	12.4	8.8	12.0	15.8	11.1	14.1	17.6	14.0	16.8		
	Connection	m	250		300			350			400			450			
Gas	High Heating Value	kcal/Nm³	10,400														
	Flow rate	Nm³/h	109.0	121.2	135.7	152.7	169.6	193.8	218.1	242.3	266.5	290.8	315.0	339.2	363.5		
	Inlet Pressure	mmAq	4,000														
	Connection	mm	50 (4,000mmAq)						65 (4,000mmAq)								
	Exhaust gas	mm	410 x 310			350 x 500			400 x 620			400 x 900					
Electric	Power source	-	3PH, 400V, 50Hz														
	Ref. Pump	kW	0.4				1.5										
	Abs. Pump1	kW	3.2		5.5					7.5							
	Abs. Pump2	kW	0.4		2.2					4.5							
	Purge Pump	kW	0.4						0.75								
	Burner	kW	4.0				7.5				11.0						
	Control Panel	kW	0.2														
	Total kW	kW	8.6		12.7		16.2		17.3			19.7		23.2		25.5	
Total Ampere @400V	A	23.0		34.1		40.0		42.6			52.4		58.7		68.2		
Size	Length (L)	mm	4,880		4,998		5,540		6,038		5,644		6,142		6,667		
	Width (W)	mm	2,469		2,935					3,330			3,929			4,460	
	Height (H)	mm	2,633		2,962					3,310			3,500			3,700	
Weight	Rigging	ton	14.1	14.8	19.6	21.2	22.7	28.7	30.6	32.9	40.4	43.4	46.0	50.1	52.7		
	Operation	ton	15.8	16.6	22.2	24.0	25.7	32.0	34.4	37.1	45.1	48.5	51.5	56.1	59.1		
Space for Tube Replacement	mm	4,500			5,200		5,700		5,200		5,700		6,200		6,700		

### Option

1. Non-standard cooling capacity.
2. Higher working pressure (230psig = 1.6MPa, 300psig = 2.0MPa)
3. Special tubes (material) & thickness.
4. Various temp. conditions (CHW, CW, HW)
5. Outdoor installation.
6. The specifications above are subject to change without prior notice for an improvement of the chiller.

# Double Effect Direct Fired Absorption Chiller & Heater



## Performance Data

→ →

Model		Unit	DW50	DW60	DW70	DW80	DW100	DW120	DW150	DW180	DW210	DW240	DW280	DW320	DW360	DW400	
Cooling Capacity	kW		176	211	246	281	352	422	527	633	738	844	985	1,125	1,266	1,407	
	usRT		50	60	70	80	100	120	150	180	210	240	280	320	360	400	
Heating Capacity	kW		147	176	205	235	293	352	440	528	616	704	822	939	1,056	1,174	
	Mcal/h		126	151	176	202	252	303	378	454	530	605	707	808	908	1,010	
Chilled Water	Inlet/Outlet Temp.	°C	12 / 7														
	Flow rate	m <sup>3</sup> /h	30.2	36.3	42.3	48.4	60.5	72.6	90.7	108.9	127.0	145.2	169.3	193.5	217.7	241.9	
	Pressure Drop	mH <sub>2</sub> O	4.0	3.7	6.2	6.9	5.6	5.9	7.6	8.1	7.5	7.4	5.4	5.3	5.8	6.0	
	Connection	mm	80				100				125			150			
Hot Water	Inlet/Outlet Temp.	°C	55.8 / 60														
	Flow rate	m <sup>3</sup> /h	30.2	36.3	42.3	48.4	60.5	72.6	90.7	108.9	127.0	145.2	169.3	193.5	217.7	241.9	
	Pressure Drop	mH <sub>2</sub> O	4.0	3.7	6.2	6.9	5.6	5.9	7.6	8.1	7.5		5.4	5.3	5.8	6.0	
	Connection	mm	80				100				125			150			
Cooling Water	Inlet/Outlet Temp.	°C	32 / 37.5														
	Flow rate	m <sup>3</sup> /h	50	60	70	80	100	120	150	180	210	240	280	320	360	400	
	Pressure Drop	mH <sub>2</sub> O	7.0	6.1	10.2	10.0	8.9	9.1	10.4	10.8	10.7	11.2	8.9	8.6	8.8	8.7	
Gas	High Heating Value	kcal/Nm <sup>3</sup>	10,400														
	Flow rate	Nm <sup>3</sup> /h	14.5	17.3	20.2	23.1	28.9	34.7	43.4	52.0	60.7	69.4	80.9	92.5	104.1	115.6	
	Inlet Pressure	mmAq	200				4,000										
	Connection	mm	50(200mmAq)				40(4,000mmAq)				50(4,000mmAq)						
	Exhaust gas	mm	190 X 110		270 X 150		280 X 210			310 X 310			360 X 310				
Electric	Power source	-	3PH, 400V, 50Hz														
	Ref. Pump	kW	0.2				0.3				0.4						
	Abs. Pump	kW	1.5				2.0				2.4			3.2			
	Purge Pump	kW	0.4														
	Burner	kW	0.4		0.7		1.1			2.2			4.0				
	Control Pane	kW	0.2														
	Total kW	kW	2.7		3.0		3.6		4.0		4.5		5.5		5.6		8.2
	Total Ampere @400V	A	8.7		10.0		11.6		13.8		14.3		15.7		15.9		21.6
	Size	Length (L)	mm	2,095		2,598		2,597		3,680		3,708		4,734		4,776	
Width (W)		mm	1,477		1,615		1,810		1,920		2,100		2,200		2,290		
Height (H)		mm	1,760				2,090				2,122				2,385		
Weight	Rigging	ton	2.6	2.7	3.2	3.3	4.6	4.9	5.8	6.2	7.3	7.7	8.9	9.4	11.6	12.2	
	Operation	ton	2.8	3.0	3.5	3.7	5.0	5.3	6.3	6.8	8.0	8.5	9.8	10.4	12.8	13.5	
Space for Tube Replacement	mm	1,900		2,400				3,400				4,500					
Diesel Boiler	High Heating Value	kcal/l	10,550														
	Flow Rate	l/h	16.7	20.0	23.3	26.6	33.3	40.0	50.0	59.9	69.9	79.9	93.2	107	120	133	
	Oil piping connection size	A	15A*2									20A*2					
	Exhaust gas	mm	190 X 110		270 X 150		280 X 210			310 X 310			360 X 310				

### Note

1. Working pressure of each water side is based on 1.0MPa (150psig)
2. Fouling factor 0.0001 m<sup>2</sup>.hr.°C/Kcal for Absorber, Condenser and Evaporator.
3. Min. outlet temp. of chilled water: 5°C
4. Min. allowable inlet temp. of cooling water: 20°C.
5. Controllable range shall be 25~100%.
6. Standard Power source is 3ph, 400V, 50Hz and available 220, 380, 440V and 460V power source.
7. Each water flow can be adjusted within 50~120%.

# DW Series

## Double Effect Direct Fired Absorption chiller & Heater

### Performance Data

Model		Unit	DW450	DW500	DW560	DW630	DW700	DW800	DW900	DW1000	DW1100	DW1200	DW1300	DW1400	DW1500		
Cooling Capacity	kW		1,582	1,758	1,969	2,215	2,461	2,813	3,165	3,516	3,868	4,220	4,571	4,923	5,274		
	usRT		450	500	560	630	700	800	900	1,000	1,100	1,200	1,300	1,400	1,500		
Heating Capacity	kW		1,320	1,467	1,643	1,848	2,054	2,347	2,641	2,934	3,227	3,521	3,814	4,108	4,401		
	Mcal/h		1,135	1,262	1,413	1,590	1,766	2,019	2,523	2,271	2,523	2,776	3,280	3,532	3,785		
Chilled Water	Inlet/Outlet Temp.	°C	12 / 7														
	Flow rate	m <sup>3</sup> /h	272.2	302.4	338.7	381.0	423.4	483.8	544.3	604.8	665.3	725.8	786.2	846.7	907.2		
	Pressure Drop	mH <sub>2</sub> O	5.1	5.4	4.2	5.8	7.7	5.7	7.7	10.1	6.7	8.6	10.7	8.7	10.6		
	Connection	mm	200					250			300			350			
Hot Water	Inlet/Outlet Temp.	°C	56.3 / 60														
	Flow rate	m <sup>3</sup> /h	272.2	302.4	338.7	381.0	423.4	483.8	544.3	604.8	665.3	725.8	786.2	846.7	907.2		
	Pressure Drop	mH <sub>2</sub> O	5.1	5.4	4.2	5.8	7.7	5.7	7.7	10.1	6.7	8.6	10.7	8.7	10.6		
	Connection	mm	200					250			300			350			
Cooling Water	Inlet/Outlet Temp.	°C	32 / 37.5														
	Flow rate	m <sup>3</sup> /h	450	500	560	630	700	800	900	1,000	1,100	1,200	1,300	1,400	1,500		
	Pressure Drop	mH <sub>2</sub> O	8.4	8.6	6.8	9.3	12.4	8.8	12.0	15.8	11.1	14.1	17.6	14.0	16.8		
	Connection	mm	250			300			350			400			450		
Gas	High Heating Value	kcal/Nm <sup>3</sup>	10,400														
	Flow rate	Nm <sup>3</sup> /h	130.1	144.5	161.9	182.1	202.3	231.2	260.1	289.0	318.0	346.9	375.8	404.7	433.6		
	Inlet Pressure	mmAq	4,000														
	Connection	mm	50(4,000mmAq)						400 X 620			65(4,000mmAq)					
	Exhaust gas	mm	410 X 310			350 X 500			400 X 620			400 X 900					
Electric	Power source	-	3PH, 400V, 50Hz														
	Ref. Pump	kW	0.4					1.5									
	Abs. Pump	kW	3.2			5.5			7.5								
	Purge Pump	kW	0.4						0.75								
	Burner	kW	4.0			7.5			11.0			15.0					
	Control Pane	kW	0.2														
	Total kW	kW	8.2		10.5		14.0		15.1		18.6		21.0		25.0		
	Total Ampere @400V	A	21.6		28.4		33.5		36.1		42.4		52.2		58.8		
Size	Length (L)	mm	4,880		4,998		5,540		6,038		5,644		6,142		6,667		
	Width (W)	mm	2,490			3,055			3,330			3,738			4,460		
	Height (H)	mm	2,633			2,962			3,310			3,500			3,700		
Weight	Rigging	ton	14.2	14.9	19.5	21.1	22.7	27.9	30.4	32.8	40.0	43.0	45.8	49.7	52.3		
	Operation	ton	15.8	16.6	22.2	24.0	25.7	32.0	34.4	37.1	45.1	48.5	51.5	56.1	59.1		
Space for Tube Replacement	mm	4,500			5,200		5,700		5,200		5,700		6,200		6,700		
Diesel Boiler	High Heating Value	kcal/l	10,550														
	Flow Rate	l/h	150	167	186	210	233	266	300	333	366	400	433	466	500		
	Oil piping connection size	A	20A*2				25A*2				32A*2						
	Exhaust gas	mm	410 X 310			350 X 500			400 X 620			400 X 900					

### Option

1. Non-standard cooling capacity.
2. Higher working pressure (230psig = 1.6MPa, 300psig = 2.0MPa)
3. Special tubes (material) & thickness.
4. Various temp. conditions (CHW, CW, HW)
5. Outdoor installation.
6. The specifications above are subject to change without prior notice for an improvement of the chiller.

# Steam Driven Absorption Chiller

## SWHH Series

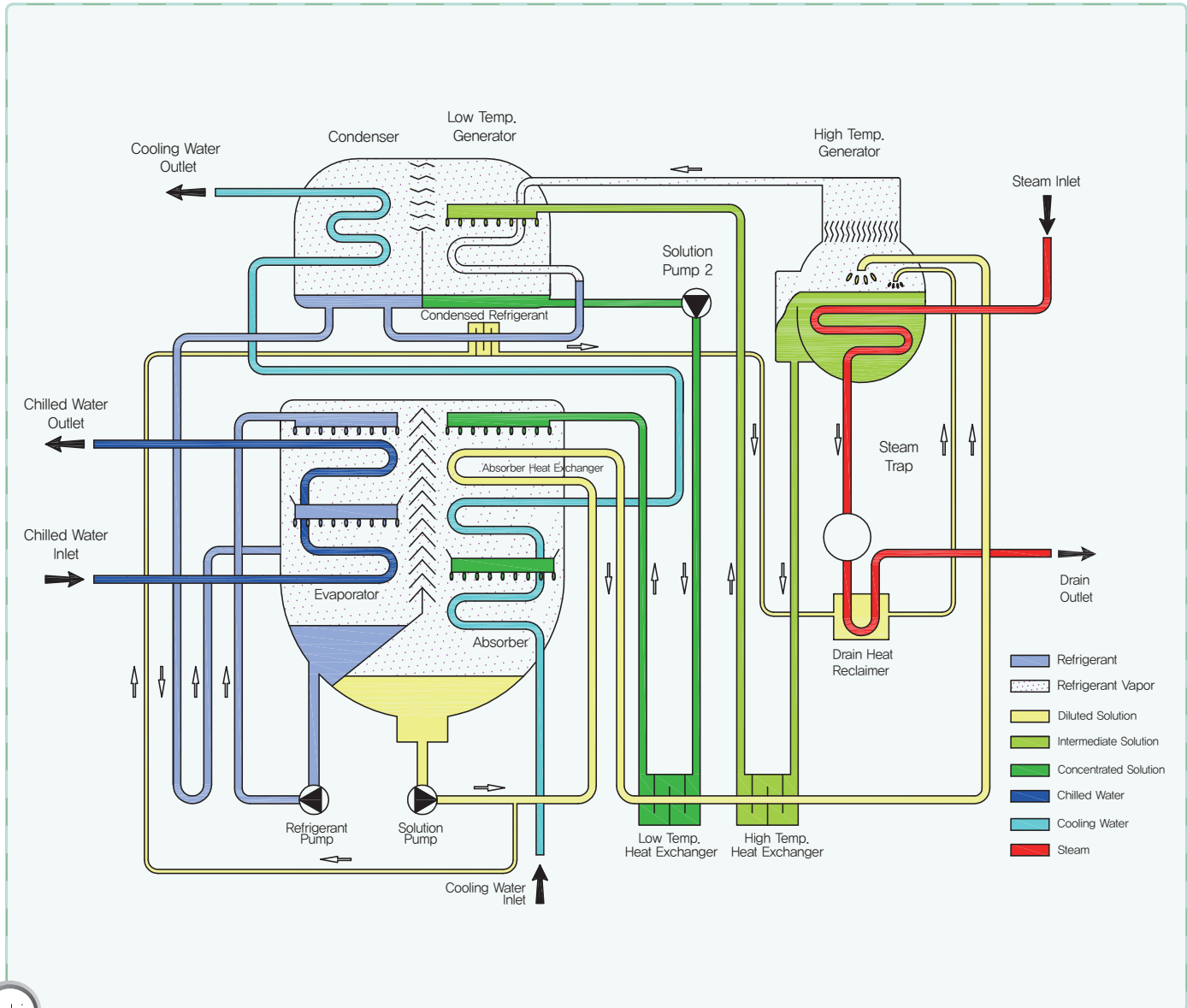

**A**bsorption chiller is composed of evaporator, absorber, condenser, low/ high temp. generator, low/ high tem. heat exchanger, solution pump #1&2, refrigerant pump, Drain Heat Reclaimer. Chilled water temp. goes down in the evaporator and steam from evaporator is absorbed into the concentrated solution in absorber. Diluted solution in absorber flows into the High Temp. Generator by solution pump through low temp./high temp. heat exchanger and it is heated by steam to become intermediated solution.

Concentrated Intermediate solution in the low temp. generator exchanges its heat in the low/high heat exchanger, low temp. solution flow back to absorber and repeat the process.

Steam in the high temp. generator exchanges its heat twice in the chiller, firstly in the high temp. generator and secondly in Drain Heat reclaimer, therefore high temp. steam drains out at low temp. like 95°C. This Process can increase heat recovery rate and chiller capacity

SWH Series

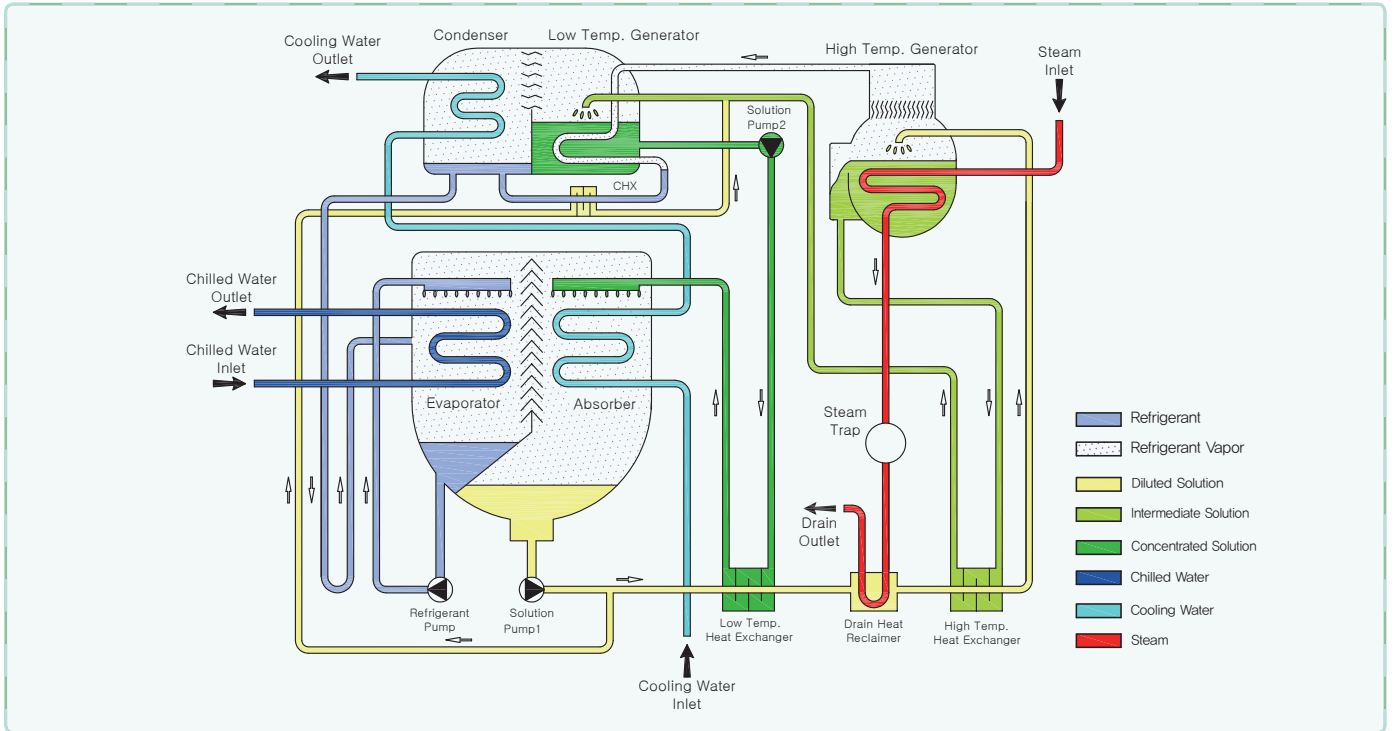

SHH Series

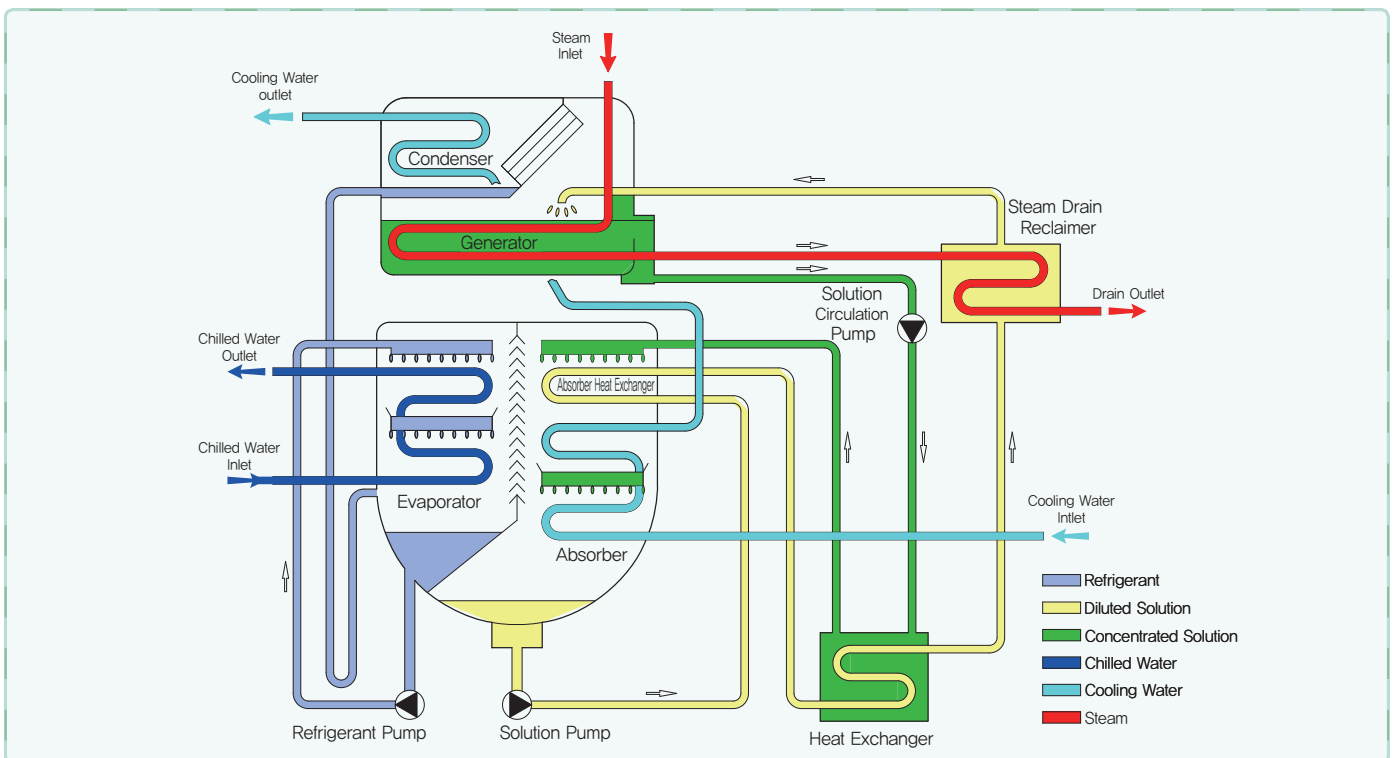



# Steam Driven Absorption Chiller



## Performance Data

→ →

Model		Unit	SWHH100	SWHH120	SWHH150	SWHH180	SWHH210	SWHH240	SWHH280	SWHH320	SWHH360	SWHH400	SWHH450	SWHH500
Cooling Capacity		kW	352	422	527	633	738	844	985	1,125	1,266	1,407	1,582	1,758
		usRT	100	120	150	180	210	240	280	320	360	400	450	500
Chilled Water	Inlet/Outlet Temp.	°C	12 / 7											
	Flow rate	m <sup>3</sup> /h	60.5	72.6	90.7	108.9	127.0	145.2	169.3	193.5	217.7	241.9	272.2	302.4
	Pressure Drop	mH <sub>2</sub> O	5.9	6.1	8.0	8.2	7.6	7.5	5.4	5.3	5.7	5.8	5.0	5.7
	Connection	mm	100			125			150			200		
Cooling Water	Inlet/Outlet Temp.	°C	32 / 37.1											
	Flow rate	m <sup>3</sup> /h	100	120	150	180	210	240	280	320	360	400	450	500
	Pressure Drop	mH <sub>2</sub> O	7.3	7.7	9.9	10.4	11.5	10.2	8.3	7.9	8.1	8.2	8.2	8.3
	Connection	mm	125		150			200			250			
Steam	Inlet Pressure	MPa	0.8											
	Flow rate	Kg/h	359	431	539	646	754	862	1,005	1,149	1,292	1,436	1,616	1,795
	Inlet Connection	mm	50				65				80			
	Drain Connection	mm	25						40					
	Control Valve	mm	40				50							
Electric	Power source	-	3PH, 400V, 50Hz											
	Ref. Pump	kW	0.2(1.2)				0.3(1.4)				0.4(1.4)			
	Abs. Pump1	kW	1.5(4.8)				2.0(5.7)				2.4(6.7)		3.0(8.6)	
	Purge Pump	kW	0.4(1.4)											
	Control Panel	kW	0.2(0.5)											
	Total kW	kW	2.3				2.9				3.3		4.0	
	Total Ampere @400V	A	7.9				9.0				10.0		11.9	
Size	Length (L)	mm	2,771		3,816		3,869		4,940		5,069		5,074	
	Width (W)	mm	1,490				1,652				2,004		1,990	
	Height (H)	mm	2,202		2,202		2,460		2,557		2,723			
Weight	Rigging	ton	4.0	4.1	5.1	5.2	5.9	6.1	7.3	7.6	9.6	9.9	11.5	11.9
	Operation	ton	4.4	4.6	5.7	5.8	6.7	7.0	8.3	8.7	10.9	11.3	13.2	13.7
Space for Tube Replacement		mm	2,400			3,400			4,600					

### Note

1. Working pressure of each water side is based on 1.0MPa (150psig)
2. Fouling factor 0.0001 m<sup>2</sup>.hr.°C/Kcal for Absorber, Condenser and Evaporator.
3. Min. outlet temp. of chilled water: 5°C
4. Min. allowable inlet temp. of cooling water: 20°C.
5. Controllable range shall be 0-100%.
6. Standard Power source is 3ph, 400V, 50Hz and available 220, 380, 440V and 460V power source.
7. Each water flow can be adjusted within 50-120%.

# SWHH Series

## Steam Driven Absorption Chiller

### Performance Data

Model		Unit	SWHH560	SWHH630	SWHH700	SWHH770	SWHH840	SWHH900	SWHH1000	SWHH1100	SWHH1200	SWHH1300	SWHH1400	SWHH1500	
Cooling Capacity		kW	1,969	2,215	2,461	2,708	2,954	3,165	3,516	3,868	4,220	4,571	4,923	5,274	
		usRT	560	630	700	770	840	900	1,000	1,100	1,200	1,300	1,400	1,500	
Chilled Water	Inlet/Outlet Temp.	°C	12 / 7												
	Flow rate	m <sup>3</sup> /h	338.7	381.0	423.4	465.7	508.0	544.3	604.8	665.3	725.8	786.2	846.7	907.2	
	Pressure Drop	mH <sub>2</sub> O	7.3	9.9	9.4	12.0	15.1	9.0	11.9	15.1	11.4	14.3	8.6	10.6	
	Connection	mm	200			250			300			350			
Cooling Water	Inlet/Outlet Temp.	°C	32 / 37.1												
	Flow rate	m <sup>3</sup> /h	560	630	700	770	840	900	1,000	1,100	1,200	1,300	1,400	1,500	
	Pressure Drop	mH <sub>2</sub> O	11.3	15.3	11.9	13.4	14.0	8.8	14.8	15.8	14.1	13.4	13.6	14.1	
	Connection	mm	250		300			350		400		450			
Steam	Inlet Pressure	MPa	0.8												
	Flow rate	Kg/h	2,010	2,262	2,513	2,764	3,016	3,231	3,590	3,949	4,308	4,667	5,026	5,385	
	Inlet Connection	mm	100			125			150						
	Drain Connection	mm	50			65			80						
	Control Valve	mm	65				80				100				
Electric	Power source	-	3PH, 400V, 50Hz												
	Ref. Pump	kW	0.4(1.4)				1.5(4.0)				1.8(6.0)				
	Abs. Pump1	kW	3.0(8.6)		4.5(12.4)			5.5(14.3)			4.5(15.2)		5.5(19.0)		
	Purge Pump	kW	0.4						0.75						
	Control Panel	kW	0.2(0.5)												
	Total kW	kW	4.0		5.5			7.6			7.0		8.3		
	Total Ampere @400V	A	11.9		15.7			20.2			21.9		27.7		
Size	Length (L)	mm	5,717	6,215	6,231	6,833	7,230	7,333	6,849	7,449	6,967	7,467	7,192	7,697	
	Width (W)	mm	2,180		2,403		2,475		2,751		3,161			3,505	
	Height (H)	mm	2,793		3,020		3,020			3,257		3,474		3,937	
Weight	Rigging	ton	16.1	17.5	18.9	20.9	22.7	23.7	26.2	28.7	31.3	33.8	36.4	38.9	
	Operation	ton	18.7	20.3	21.8	24.0	25.8	27.4	30.4	33.4	36.4	39.4	42.3	45.3	
Space for Tube Replacement		mm	5,200	5,700	5,700	6,300	6,700	5,700	6,300	6,700	6,300	6,700	6,300	6,700	

### Option

1. Non-standard cooling capacity.
2. Higher working pressure (230psig = 1.6MPa, 300psig = 2.0MPa)
3. Special tubes (material) & thickness.
4. Various temp. conditions (CHW, CW, HW)
5. Outdoor installation.
6. The specifications above are subject to change without prior notice for an improvement of the chiller.

# Steam Driven Absorption Chiller



## Performance Data

→→

Model		Unit	SWH100	SWH120	SWH150	SWH180	SWH210	SWH240	SWH280	SWH320	SWH360	SWH400	SWH450	SWH500		
Cooling Capacity		kW	352	422	527	633	738	844	985	1,125	1,266	1,407	1,582	1,758		
		usRT	100	120	150	180	210	240	280	320	360	400	450	500		
Chilled Water	Inlet/Outlet Temp.	°C	12 / 7													
	Flow rate	m <sup>3</sup> /h	60.5	72.6	90.7	108.9	127.0	145.2	169.3	193.5	217.7	241.9	272.2	302.4		
	Pressure Drop	mH <sub>2</sub> O	5.6	5.9	7.6	8.1	7.5	7.4	5.4	5.3	5.8	6.0	5.1	5.4		
	Connection	mm	100				125			150				200		
Cooling Water	Inlet/Outlet Temp.	°C	32 / 37.2													
	Flow rate	m <sup>3</sup> /h	100	120	150	180	210	240	280	320	360	400	450	500		
	Pressure Drop	mH <sub>2</sub> O	8.9	9.1	10.4	10.8	10.7	11.2	8.9	8.6	8.8	8.7	8.4	8.6		
	Connection	mm	125		150				200				250			
Steam	Inlet Pressure	MPa	0.8													
	Flow rate	kg/h	390	468	585	702	819	936	1,092	1,248	1,404	1,560	1,755	1,950		
	Inlet Connection	mm	50				65				80					
	Drain Connection	mm	25										40			
	Control Valve	mm	40					50					65			
Electric	Power source	–	3PH / 400V / 50Hz													
	Ref. Pump	kW	0.3				0.4				0.4					
	Abs. Pump1	kW	2.0				2.4				3.2					
	Abs. Pump2	kW	0.3				0.4				0.4					
	Purge Pump	kW	0.4													
	Control Panel	kW	0.2													
	Total kW	kW	3.2				3.7				3.8				4.6	
Total Ampere @400V	A	10.9				11.4				11.6				13.7		
Size	Length (L)	mm	2,597		3,680			3,708			4,734			4,776		4,880
	Width (W)	mm	1,420				1,652				1,735				1,954	
	Height (H)	mm	2,200				2,250				2,450				2,600	
Weight	Rigging	ton	4.0	4.1	5.1	5.2	5.9	6.1	7.3	7.6	9.6	9.9	11.5	11.9		
	Operation	ton	4.4	4.6	5.7	5.8	6.7	7.0	8.3	8.7	10.9	11.3	13.2	13.7		
Space for Tube Replacement	mm	2,400			3,400				4,500							

### Note

- Working pressure of each water side is based on 1.0MPa (150psig)
- Fouling factor 0.0001 m<sup>2</sup>.hr.°C/Kcal for Absorber, Condenser and Evaporator.
- Min. outlet temp. of chilled water: 5°C
- Min. allowable inlet temp. of cooling water: 20°C.
- Controllable range shall be 0~100%.
- Standard Power source is 3ph, 400V, 50Hz and available 220, 380, 440V and 460V power source.
- Each water flow can be adjusted within 50~120%.

# SWH Series

## Steam Driven Absorption Chiller

### Performance Data

Model		Unit	SWH560	SWH630	SWH700	SWH800	SWH900	SWH1000	SWH1100	SWH1200	SWH1300	SWH1400	SWH1500	
Cooling Capacity		kW	1,969	2,215	2,461	2,813	3,465	3,516	3,868	4,220	4,571	4,923	5,274	
		usRT	560	630	700	800	900	1,000	1,100	1,200	1,300	1,400	1,500	
Chilled Water	Inlet/Outlet Temp.	°C	12 / 7											
	Flow rate	m <sup>3</sup> /h	338.7	381.0	423.4	483.8	544.3	604.8	665.3	725.8	786.2	846.7	907.2	
	Pressure Drop	mH <sub>2</sub> O	4.2	5.8	7.7	5.7	7.7	10.1	6.7	8.6	10.7	8.7	10.6	
	Connection	mm	200			250			300			350		
Cooling Water	Inlet/Outlet Temp.	°C	32 / 37.2											
	Flow rate	m <sup>3</sup> /h	560	630	700	800	900	1,000	1,100	1,200	1,300	1,400	1,500	
	Pressure Drop	mH <sub>2</sub> O	6.8	9.3	12.4	8.8	12.0	15.8	11.1	14.1	17.6	14.0	16.8	
	Connection	m	300			350			400			450		
Steam	Inlet Pressure	MPa	0.8											
	Flow rate	kg/h	2,184	2,457	2,730	3,120	3,510	3,900	4,290	4,680	5,070	5,460	5,850	
	Inlet Connection	mm	100			125			150					
	Drain Connection	mm	50			65			80					
	Control Valve	mm	65	80				100						
Electric	Power source	–	3PH / 400V / 50Hz											
	Ref. Pump	kW	0.4				1.5							
	Abs. Pump1	kW	5.5					7.5						
	Abs. Pump2	kW	2.2								4.5			
	Purge Pump	kW	0.4						0.75					
	Control Panel	kW	0.2											
	Total kW	kW	8.7				9.8				12.2			
Total Ampere @400V	A	24.8				27.4				37.2				46.7
Size	Length (L)	mm	4,998	5,540	6,038	5,644	6,142	6,667	6,293	6,818	7,318	6,860	7,360	
	Width (W)	mm	2,180			2,606			3,000			3,250		
	Height (H)	mm	2,900			3,350			3,450			3,650		
Weight	Rigging	ton	16.1	17.5	18.9	21.1	23.7	26.2	28.7	31.3	33.8	36.4	38.9	
	Operation	ton	18.7	20.3	21.8	24.5	27.4	30.4	33.4	36.4	39.4	42.3	45.3	
Space for Tube Replacement	mm	4,500	5,200	5,700	5,200	5,700	6,200	5,700	6,200	6,700	6,200	6,700		

### Option

1. Non-standard cooling capacity.
2. Higher working pressure (230psig = 1.6MPa, 300psig = 2.0MPa)
3. Special tubes (material) & thickness.
4. Various temp. conditions (CHW, CW, HW)
5. Outdoor installation.
6. The specifications above are subject to change without prior notice for an improvement of the chiller.

# Steam Driven Absorption Chiller



## Performance Data

→ →

Model		Unit	S50HH	S60HH	S70HH	S80HH	S100HH	S120HH	S150HH	S180HH	S210HH	S240HH	S280HH	S320HH	S360HH	S400HH			
Cooling Capacity		kW	176	211	246	281	352	422	527	633	738	844	985	1,125	1,266	1,407			
		usRT	50	60	70	80	100	120	150	180	210	240	280	320	360	400			
Chilled Water	Inlet Temp./Outlet Temp.	°C	12 / 7																
	Flow rate	m <sup>3</sup> /h	30.2	36.3	42.3	48.4	60.5	72.6	90.7	109	127	145	169	194	218	242			
	Pressure Drop	mH <sub>2</sub> O	6.8	6.4	5.8	6.0	5.9	6.1	8.0	8.2	7.5	7.4	5.4	5.3	5.7	5.8			
	Connection	mm	80				100				150								
Cooling Water	Inlet Temp./Outlet Temp.	°C	32 / 39																
	Flow rate	m <sup>3</sup> /h	48.2	57.8	67.5	77.1	96.4	116	145	174	202	231	270	308	347	386			
	Pressure Drop	mH <sub>2</sub> O	6.0	5.5	7.2	7.2	6.6	7.0	9.3	9.7	9.5	9.0	7.8	7.4	7.6	7.7			
	Connection	mm	100				150				200								
Steam	Inlet Pressure	MPa	0.15																
	Flow rate	kg/h	336	404	471	538	673	807	1,009	1,211	1,412	1,614	1,883	2,152	2,421	2,690			
	Inlet Connection	mm	105.3				130.8				155.2				204.7				
	Drain Connection	mm	25				40				50								
	Control Valve	mm	40			50			65			80			100			125	
Electric	Power source	-	3Φ, 380V, 60Hz																
	Abs. Pumps	kW(A)	0.3(1.4)				0.4(1.4)				1.5(4.3)								
	Ref. Pump	kW(A)	0.2(1.2)				0.3(1.4)												
	Purge Pump	kW(A)	0.4(1.4)																
	Control Panel	kW(A)	0.2(0.5)																
	Total kW	kW	1.1				1.2				1.3				2.4				
	Total Ampere @400V	A	4.5				4.7				7.6								
Size	Length (L)	mm	2,110		2,610		2,658		3,678		3,728		4,748		4,854				
	Width (W)	mm	1,072				1,151				1,222				1,395				
	Height (H)	mm	2,097				2,372				2,640				2,677				
Weight	Rigging	ton	2.3	2.4	2.7	2.7	3.5	3.5	4.2	4.5	5.4	5.7	6.5	6.8	8.2	8.5			
	Operation	ton	2.6	2.7	3.0	3.1	4.0	4.1	4.9	5.2	6.4	6.8	7.7	8.1	9.7	10.2			
Space for Tube Replacement		mm	1,900			2,400			3,400			4,600							
Water Volume of Machine	Chilled Water Side	ℓ	60	67	77	80	111	123	142	159	216	237	258	286	324	348			
	Cooling Water Side	ℓ	215	235	265	276	309	336	391	432	569	622	694	765	927	993			
	Hot Water Side	ℓ	51	62	71	79	98	107	127	142	170	189	214	239	278	303			

### Note

- Working pressure of each water side is based on 1.0MPa (150psig)
- Fouling factor 0.0001 m<sup>2</sup>.hr. °C/Kcal for Absorber, Condenser and Evaporator.
- Min. outlet temp. of chilled water: 5°C
- Min. allowable inlet temp. of cooling water: 20°C.
- Controllable range shall be 0~100%.
- Standard Power source is 3ph, 400V, 50Hz and available 220, 380, 440V and 460V power source.
- Each water flow can be adjusted within 50~120%.

# SHH Series

## Steam Driven Absorption Chiller

### Performance Data

Model		Unit	S450HH	S500HH	S560HH	S630HH	S700HH	S770HH	S840HH	S900HH	S1000HH	S1100HH	S1200HH	S1300HH	S1400HH	S1500HH		
Cooling Capacity		kW	1,582	1,758	1,969	2,215	2,461	2,708	2,954	3,165	3,516	3,868	4,220	4,571	4,923	5,274		
		usRT	450	500	560	630	700	770	840	900	1,000	1,100	1,200	1,300	1,400	1,500		
Chilled Water	Inlet Temp./Outlet Temp.	°C	12 / 7															
	Flow rate	m <sup>3</sup> /h	272	302	339	381	423	466	508	544	605	665	726	786	847	907		
	Pressure Drop	mH <sub>2</sub> O	5.0	5.3	7.3	9.9	9.2	12.0	15.1	9.0	11.9	15.2	11.4	14.3	8.6	10.6		
	Connection	mm	200				250				300			350				
Cooling Water	Inlet Temp./Outlet Temp.	°C	32 / 39															
	Flow rate	m <sup>3</sup> /h	434	482	540	607	675	742	810	868	964	1,060	1,157	1,253	1,350	1,446		
	Pressure Drop	mH <sub>2</sub> O	7.7	7.8	6.7	9.0	7.2	9.3	9.4	7.2	9.9	9.7	9.0	9.0	7.7	9.4		
	Connection	mm	250				300				350			400				
Steam	Inlet Pressure	MPa	0.15															
	Flow rate	kg/h	3026	3363	3766	4237	4708	5179	5649	6053	6725	7398	8070	8743	9416	10088		
	Inlet Connection	mm	204.7			254.2			304.7				339.8			390.6		
	Drain Connection	mm	65				80				100							
	Control Valve	mm	125				150				200							
Electric	Power source	-	3Φ, 380V, 60Hz															
	Abs. Pumps	kW(A)	1.5(4.3)						1.8(6.0)						2.2(6.7)			
	Ref. Pump	kW(A)	0.4(1.4)						1.5(4.0)						1.8(6)			
	Purge Pump	kW(A)	0.4(1.4)						0.75(2.2)									
	Control Panel	kW(A)	0.2(0.5)															
	Total kW	kW	2.5						3.9						4.3		5.0	
	Total Ampere @400V	A	7.6						11.9						12.7		15.4	
Size	Length (L)	mm	4,872		5,414	5,912	6,012	6,537	7,037	6,114	6,639	7,139	6,749	7,249	7,522	8,022		
	Width (W)	mm	1,557				1,780				2,177			2,467		3,000		
	Height (H)	mm	2,880				3,140				3,461			3,750		3,800		
Weight	Rigging	ton	9.9	11.5	13.1	14.9	15.9	17.1	18.1	22.4	22.7	25.6	27.2	28.7	35.2	37.1		
	Operation	ton	12.1	13.8	15.5	17.5	19.2	20.6	21.8	26.8	27.3	30.5	33.3	35.1	44.0	46.3		
Space for Tube Replacement		mm	4,600		5,200	5,700		6,200	6,700	5,700	6,200	6,700	6,200	6,700	6,300	6,800		
Water Volume of Machine	Chilled Water Side	ℓ	465	485	526	563	656	701	744	944	1,004	1,060	1,355	1,423	1,795	1,890		
	Cooling Water Side	ℓ	1,252	1,325	1,425	1,517	1,959	2,082	2,199	3,127	2,738	2,890	3,563	3,746	4,691	4,919		
	Hot Water Side	ℓ	334	365	407	448	485	523	553	578	784	837	870	932	1,067	1,138		

### Option

1. Non-standard cooling capacity.
2. Higher working pressure (230psig = 1.6MPa, 300psig = 2.0MPa)
3. Special tubes (material) & thickness.
4. Various temp. conditions (CHW, CW, HW)
5. Outdoor installation.
6. The specifications above are subject to change without prior notice for an improvement of the chiller.



# Double Effect Steam Fired Maritime Absorption chiller

**COP  
1.21**

## World Energy Absorption Chiller is certified for seaworthiness at seagoing condition

Capacity : 50~1,100usRT Service Condition : Chilled water 12/7c Cooling water : 32/37c Driving Heat source : 6bar  
Refrigerant : Distilled water, Absorbent : LiBr Solution

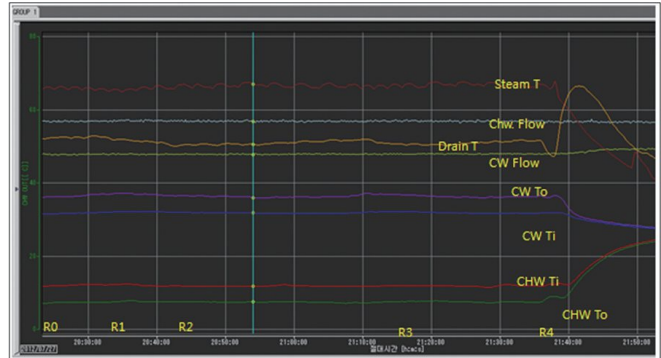

### Ship Movement Test

- Rolling condition test

### Chiller Temperature Variation

- Stabilized Temperature at Rolling and Pitching condition

## Performance Data

Model		Unit	SWM60	SWM70	SWM80	SWM100	SWM120	SWM150	SWM180	SWM210	SWM240	SWM280	SWM320	SWM360						
Cooling Capacity		kW	176	211	246	281	352	422	527	633	738	844	985	1,125						
		usRT	50	60	70	80	100	120	150	180	210	240	280	320						
Chilled Water	Inlet/Outlet Temp.	°C	12 / 7																	
	Flow rate	m <sup>3</sup> /h	30	36	42	48	60	73	91	109	127	145	169	194						
	Pressure Drop	mH <sub>2</sub> O	2.7	4.7	5.4	3.7	4.2	5.1	5.8	5.7	5.8	4.1	4.2	4.7						
	Connection	mm	80			100			125			150								
Cooling Water	Inlet/Outlet Temp.	°C	32 / 37																	
	Flow rate	m <sup>3</sup> /h	55	66	77	88	110	132	165	198	231	265	309	353						
	Pressure Drop	mH <sub>2</sub> O	4.6	8.1	8.2	6.2	6.9	7.3	8.1	8.5	9.2	7.1	7.1	7.4						
	Connection	mm	100			125			150			200								
Steam	Inlet Pressure	MPa	0.6																	
	Flow rate	kg/h	216	259	303	346	432	519	649	778	908	1,038	1,211	1,384						
	Inlet Connection	mm	40			50			65			80								
	Drain Connection	mm	25																	
	Control Valve	mm	32			40			50			65								
Electric	Power source	-	3PH, 440V, 60Hz																	
	Abs. Pumps	kW	0.2			0.3			0.4			0.4								
	Ref. Pump	kW	1.5			1.8			2.4			3.2								
	Purge Pump	kW	0.4																	
	Control Panel	kW	0.2																	
	Total Ampere	kW	2.3			2.7			3.4			4.2								
	Total Current	A	6.9			8.0			10.2			12.3								
Size	Length [L]	mm	2,600			2,716			3,680			3,717			4,734			4,872		
	Width [W]	mm	1,400																	
	Height [H]	mm	1,877			2,166			2,147			2,399								
Weight	Rigging	ton	3.5	3.6	3.7	3.8	3.9	4.9	5.2	5.9	6.4	7.4	7.8	9.6						
	Operation	ton	3.9	4	4.1	4.2	4.4	5.5	5.8	6.7	7.2	8.4	8.9	10.9						
Space for Tube Replacement	mm	1900	2400			2,400			3,400			4,500								

# SWM Series

## Double Effect Steam Fired Maritime Absorption chiller

### GL Certificate & Patent of Maritime Absorption chiller

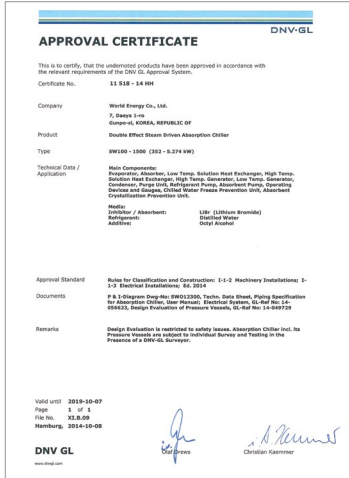

### Development

- The absorption chiller has been used for many years as an onshore applications. World energy succeeded in developing Maritime absorption chiller which runs safely under seagoing conditions.

### Energy saving

- Maritime absorption chiller is recovering surplus heat of the vessel so will save approximately 80% electrical energy compared to conventional electrical chiller.
- Compared to the traditional refrigerant system, use of the absorption system will reduce CO<sub>2</sub> emission up to 800tons/year and also conventional refrigerant Freon gas is substituted by eco-friendly distilled water.

Model		Unit	SWM400	SWM450	SWM500	SWM560	SWM630	SWM700	SWM800	SWM900	SWM1000	SWM1100	SWM1200		
Cooling Capacity		kW	1,266	1,407	1,582	1,758	1,969	2,215	2,461	2,813	3,165	3,516	3,868		
		usRT	360	400	450	500	560	630	700	800	900	1,000	1,100		
Chilled Water	Inlet/Outlet Temp.	°C	12 / 7												
	Flow rate	m <sup>3</sup> /h	218	242	272	302	339	381	423	484	544	605	665		
	Pressure Drop	mH <sub>2</sub> O	5.0	4.1	4.5	3.4	4.7	6.4	4.5	6.2	8.4	5.6	7.4		
	Connection	mm	150	200					250			300			
Cooling Water	Inlet/Outlet Temp.	°C	32 / 37												
	Flow rate	m <sup>3</sup> /h	397	441	496	551	617	694	772	882	992	1,102	1,212		
	Pressure Drop	mH <sub>2</sub> O	7.5	7.1	7.4	5.8	7.9	10.7	7.2	10.1	13.7	9.8	12.6		
	Connection	mm	200	250		300			350			400			
Steam	Inlet Pressure	MPa	0.6												
	Flow rate	kg/h	1,556	1,729	1,946	2,162	2,421	2,724	3,026	3,459	3,891	4,323	4,756		
	Inlet Connection	mm	80					100			125		150		
	Drain Connection	mm	40					50			65		80		
	Control Valve	mm	65					80			100				
Electric	Power source	-	3PH, 440V, 60Hz												
	Abs. Pumps	kW	0.4								1.5				
	Ref. Pump	kW	3.2					5.5			7.5				
	Purge Pump	kW	0.4					0.75							
	Control Panel	kW	0.2												
	Total Ampere	kW	4.2					6.5			7.6		10.0		
	Total Current	A	12.3					18.3			20.9		30.7		
Size	Length (L)	mm	4,872	4,876		4,998	5,534	6,038	5,953	6,410	6,650	6,293	6,818		
	Width (W)	mm	1,920	2,138					2,344			2,631			
	Height (H)	mm	2,399	2,667		2,860			3,176			3,450			
Weight	Rigging	ton	10.1	11.6	12.0	16.1	17.5	18.9	21.1	23.7	26.2	28.7	31.3		
	Operation	ton	11.5	13.3	13.8	18.7	20.3	21.8	24.5	27.4	30.4	33.4	36.4		
Space for Tube Replacement	mm	4,500					5,200	5,700	5,200	5,700	6,200	5,700	6,200		

# Double Effect Exhaust Gas Driven Absorption Chiller

## CHPH Series

### • Cooling Cycle

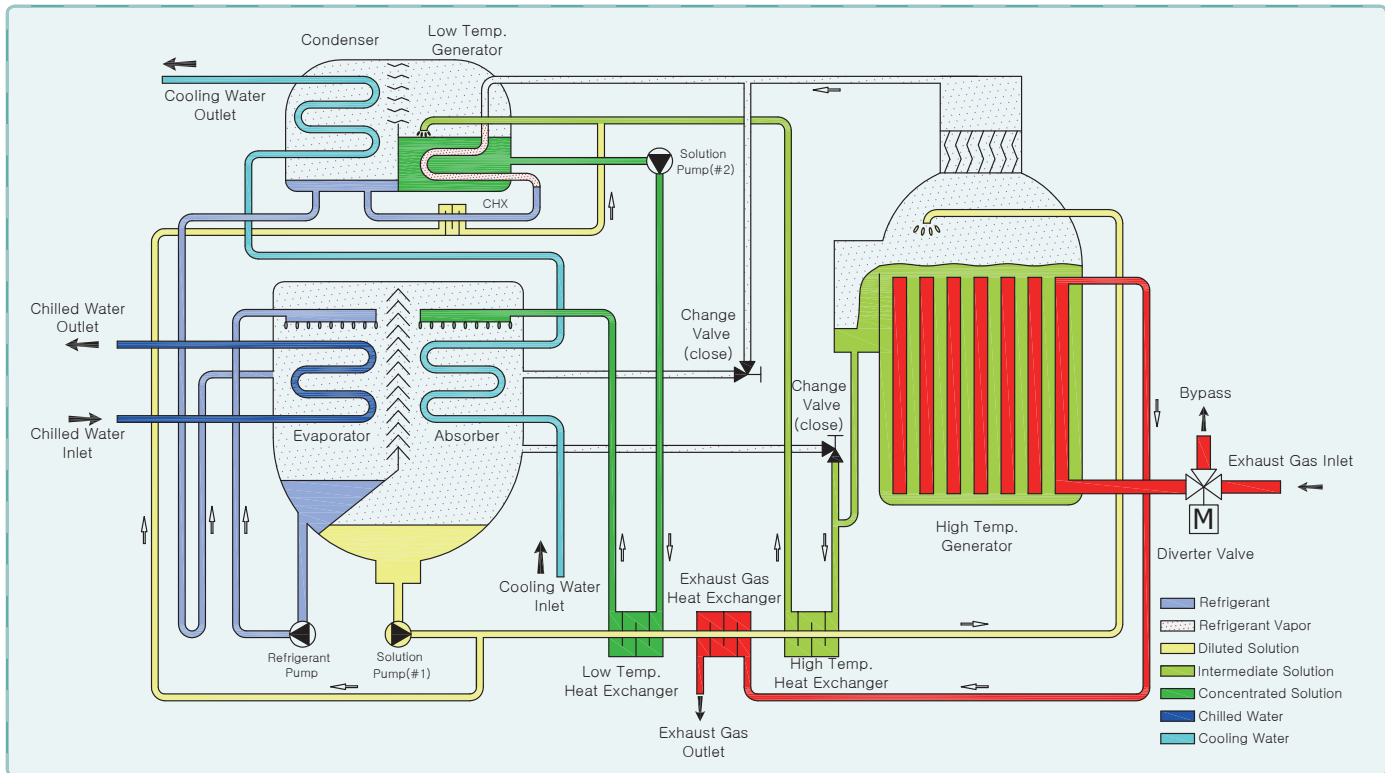

The double-effect, exhaust-gas driven absorption machine is consisted of an evaporator, absorber, condenser, high/low temperature generators, solution heat exchangers, refrigerant & solution pumps, purge system, controls and accessories.

When the chiller is under cooling mode, water boils at a low temperature approximately at  $4.4^{\circ}\text{C}$  ( $40^{\circ}\text{F}$ ) because it is under vacuum condition. Thereby chilled water is cooled down through the tubes in evaporator by the evaporative latent heat. The process of this cycle is like below. A refrigerant pump is used to spray the refrigerant (distilled water) over the evaporator tubes to improve heat transfer.

To make the cooling process continuous, the refrigerant (water) vapor flows into the absorber and it is absorbed in lithium bromide solution (which has a high affinity for water). As this process continues, the lithium bromide becomes diluted solution and reduce its absorption capacity. A solution pump then transfers this diluted solution to the generators where it is re-concentrated in two stages (double-effect) to boil off the previously absorbed water.

The diluted solution is pumped to the high-temperature generator where it is heated and re-concentrated to a medium concentration solution by the exhaust heat from the gas turbine or reciprocating engine exhaust gas. The intermediate solution from the high-temperature generator flows to the low-temperature generator where it is heated to become a

concentrated solution by the high temperature water vapor released from the solution in the high temperature generator.

Since the low-stage generator acts as the condenser for the high-stage generator, the heat energy firstly applied in the high-stage generator is used again in the low-stage generator, thus reduced heat input is approximately 45% compared to an single-stage chiller.

Vapor released in the shell side of the low-stage generator enters the condenser to be cooled and return to a liquid state. The refrigerant water then returns to the evaporator to begin a new cycle.

To remove heat from the machine, cooling water from a cooling tower is firstly circulated through the tubes of the absorber to remove the heat of vaporization. The water is then circulated through the tubes of the condenser. The re-concentrated (strong) solution from the low temp. generator flows back to the absorber to begin a new cycle.

For efficiency purposes, the medium concentration solution from the high-temp. generator passes through the high-temperature solution heat exchanger to pre-heat the diluted (weak) solution, while pre-cooling the medium concentration solution. The re-concentrated (strong) solution from the low-temp. generator passes through the low temperature solution heat exchanger to pre-heat/cool the solution before being returned to the absorber.

• Heating Cycle

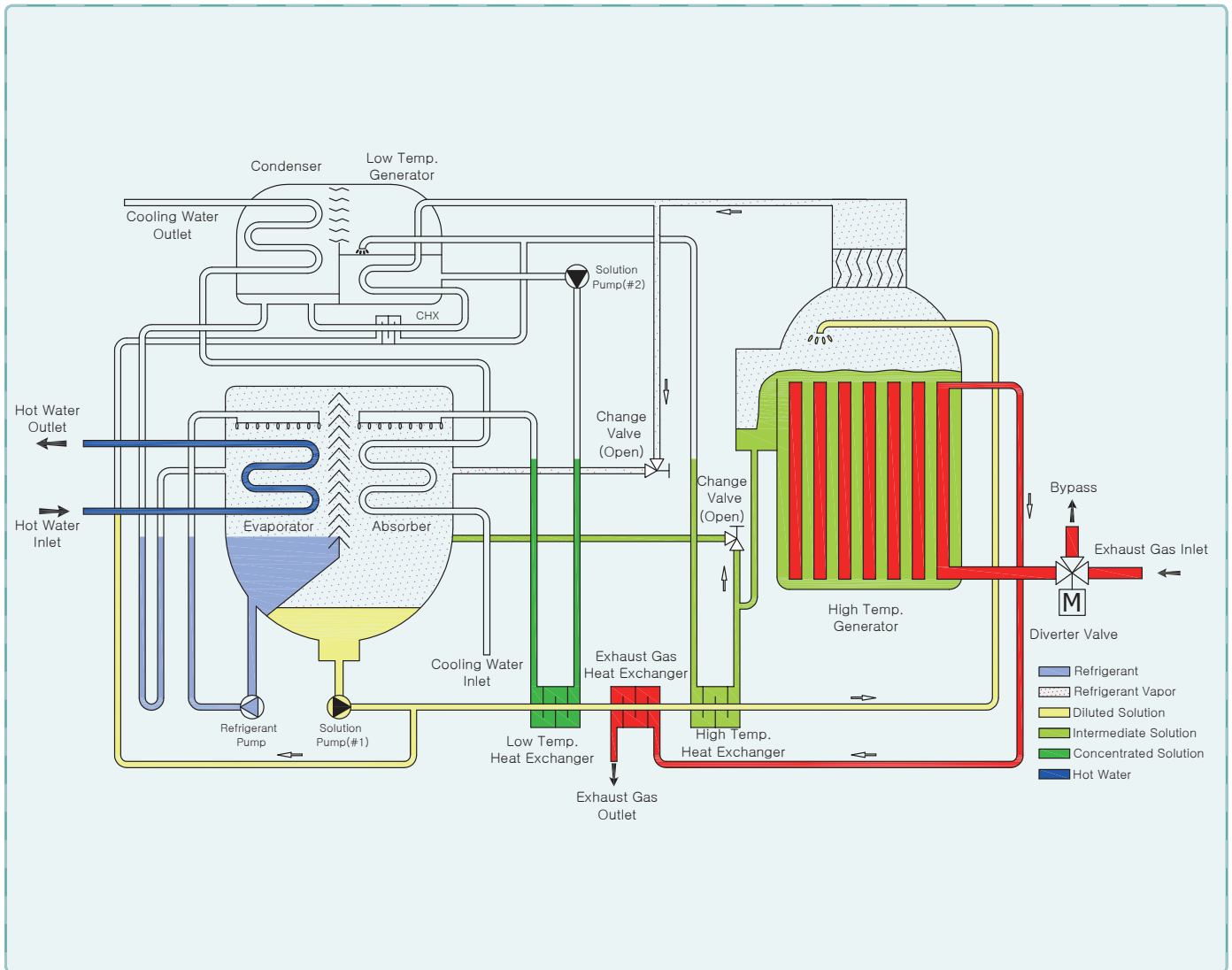

During heating mode, the absorber-condenser cooling water circuit is different from typical absorption process. High temperature water vapor produced in the high-temperature generator section passes directly to the evaporator via the absorber and transfers its heat to the tube bundles and hot water is heated from 55°C to 60°C. The Condensed water in evaporator flows to the absorber section and be mixed with the concentrated solution returning from the igh-temperature generator.

The diluted solution is pumped back to the high temperature generator to repeat the vapor generation phase for the heating function. To changeover the chiller mode from cooling to heating is simple. Change the position of chiller mode in the control panel first and drain the absorber-condenser water circuit and put the machine into heating mode by switching the positions of change valve. The hot water inlet temperatures is 60°C (140°F) as a standard and 80°C (176°F) as an option with the additional heat exchanger.

# Double Effect Exhaust Gas Fired Absorption Chiller



## Performance Data

→ →

Model	Unit	CHP005H	CHP006H	CHP007H	CHP008H	CHP010H	CHP012H	CHP015H	CHP018H	CHP021H	CHP024H	CHP028H	CHP032H	CHP036H	CHP040H				
Cooling Capacity	usRT	50	60	70	80	100	120	150	180	210	240	280	320	360	400				
	kW	176	211	246	281	352	422	527	633	738	844	985	1,125	1,266	1,407				
Chilled Water	Inlet/Outlet Temp.	12 / 7 °C																	
	Flow rate	ton/h	30.2	36.3	42.3	48.4	60.5	72.6	90.7	108.9	127.0	145.2	169.3	193.5	217.7	241.9			
	Pressure Drop	mH <sub>2</sub> O	7.5	6.9	6.3	6.9	5.9	6.1	8.0	8.2	7.6	7.5	5.4	5.3	5.7	5.8			
	Connection	mm	80				100				125		150						
Cooling Water	Inlet/Outlet Temp.	32 / 37.1 °C																	
	Flow rate	m <sup>3</sup> /h	50	60	70	80	100	120	150	180	210	240	280	320	360	400			
	Pressure Drop	mH <sub>2</sub> O	7.3	6.1	8.0	7.6	7.3	7.7	9.9	10.4	11.5	10.2	8.3	7.9	8.1	8.2			
	Connection	mm	100				125			150			200						
Heating Capacity	Mcal/h	103	123	144	165	206	247	309	370	432	494	576	658	741	823				
	kW	120	143	167	191	239	287	359	430	502	574	669	765	861	956				
Hot Water	Inlet/Outlet Temp.	56.6 / 60 °C																	
	Flow rate	ton/h	30.2	36.3	42.3	48.4	60.5	72.6	90.7	108.9	127.0	145.2	169.3	193.5	217.7	241.9			
	Pressure Drop	mH <sub>2</sub> O	7.5	6.9	6.3	6.9	5.9	6.1	8.0	8.2	7.6	7.5	5.4	5.3	5.7	5.8			
	Connection	mm	80				100				125		150						
Exhaust Gas	Gas Flow rate	kg/sec	0.305	0.366	0.427	0.488	0.610	0.732	0.915	1.098	1.281	1.464	1.708	1.952	2.195	2.439			
	Inlet/Outlet Temp @ Cooling	°C	450 / 120																
	Inlet/Outlet Temp @ Heating	°C	450 / 125																
	Pressure Drop	mmH <sub>2</sub> O	48	53	66	69	58	99	69	95	88	109	117	145	101	129			
	Inlet Connection	mm-mm	782×291	782×330	782×369	782×408	922×408	922×486	922×603	922×642	922×681	922×681	922×798	922×876	1376×720	1376×759			
	Outlet Connection	mm	300				400				500				600				
	Diverter Valve	mm	300				400				500				600				
Electric	Power source	-	3PH, 400V, 50Hz																
	Absorbent Pump	kW	1.2(3.8)				1.5(4.8)				2.0(5.7)				2.4(6.7)				
	Refrigerant Pump	kW	0.2 (1.2)																
	Purge Pump	kW	0.4 (1.4)																
	Sealing Blower	kW	0.75(2.4)				1.5(3.4)												
	Control Panel	kW	0.2 (0.5)																
	Total kW	kW	2.8				3.8				4.4				4.8				
	Total Ampere @ 400V	A	9.3				11.3				12.4				13.4				
External Dimension	Length (L)	mm	2,110			2,610			2,658			3,678			3,728		4,748		4,854
	Width (W)	mm	1,683	1,722	1,761	1,800	1,857	1,935	1,965	1,984	2,194		2,310		2,349				
	Height (H)	mm	2,017				2,202				2,460				2,557				
Weight	Rigging	ton	3.0	3.2	3.7	3.9	5.0	5.3	6.4	6.8	7.9	8.5	9.8	10.3	12.8	13.2			
	Operation	ton	3.2	3.5	4.0	4.3	5.4	5.8	7.0	7.4	8.6	9.3	10.7	11.3	14.0	14.6			
Space tube Replacement	mm	1,900		2,400	2,400	2,400	2,400	3,400				4,600							

### Note

- Working pressure of each water side is based on 1.0MPa (150psig)
- Fouling factor 0.0001 m<sup>2</sup>.hr. °C/Kcal for Absorber, Condenser and Evaporator.
- Min. outlet temp. of chilled water: 5 °C
- Min. allowable inlet temp. of cooling water: 20 °C.
- Controllable range shall be 0~100%.
- Standard Power source is 3ph, 400V, 50Hz and available 220, 380, 440V and 460V power source.
- Each water flow can be adjusted within 50~120%.

# CHPH Series

## Double Effect Exhaust Gas Driven Absorption Chiller & Heater

### Performance Data

Model		Unit	CHP045H	CHP050H	CHP056H	CHP063H	CHP070H	CHP077H	CHP084H	CHP090H	CHP100H	CHP110H	CHP120H	CHP130H	CHP140H	CHP150H	
Cooling Capacity		usRT	450	500	560	630	700	770	840	900	1,000	1,100	1,200	1,300	1,400	1,500	
		kW	1,582	1,758	1,969	2,215	2,461	2,708	2,954	3,165	3,516	3,868	4,220	4,571	4,923	5,274	
Chilled Water	Inlet/Outlet Temp.	°C	12 / 7														
	Flow rate	ton/h	272.2	302.4	338.7	381.0	423.4	465.7	508.0	544.3	604.8	665.3	725.8	786.2	846.7	907.2	
	Pressure Drop	mH <sub>2</sub> O	5.0	5.3	7.3	9.9	9.4	12.0	15.1	9.0	11.9	15.1	11.4	14.3	8.6	10.6	
	Connection	mm	200				250				300				350		
Cooling Water	Inlet/Outlet Temp.	°C	32 / 37.1														
	Flow rate	m <sup>3</sup> /h	450	500	560	630	700	770	840	900	1,000	1,100	1,200	1,300	1,400	1,500	
	Pressure Drop	mH <sub>2</sub> O	8.2	8.3	11.3	15.3	11.9	13.4	14.0	8.8	14.8	15.8	14.1	13.4	13.6	14.1	
	Connection	mm	250			300			350			400					
Heating Capacity		Mcal/h	926	1,029	1,152	1,296	1,440	1,584	1,728	1,851	2,057	2,263	2,469	2,674	2,880	3,086	
		kW	1,076	1,195	1,339	1,506	1,674	1,841	2,008	2,152	2,391	2,630	2,869	3,108	3,347	3,586	
Hot Water	Inlet/Outlet Temp.	°C	56.6 / 60														
	Flow rate	ton/h	272.2	302.4	338.7	381.0	423.4	465.7	508.0	544.3	604.8	665.3	725.8	786.2	846.7	907.2	
	Pressure Drop	mH <sub>2</sub> O	5.0	5.3	7.3	9.9	9.4	12.0	15.1	9.0	11.9	15.1	11.4	14.3	8.6	10.6	
	Connection	mm	200				250				300				350		
Exhaust Gas	Gas Flow rate	kg/sec	2.744	3.049	3.415	3.842	4.269	4.696	5.123	5.489	6.099	6.708	7.318	7.928	8.538	9.148	
	Inlet/Outlet Temp @ Cooling	°C	450 / 120														
	Inlet/Outlet Temp @ Heating	°C	450 / 125														
	Pressure Drop	mmH <sub>2</sub> O	135	135	106	103	117	120	122	121	151	152	159	156	154	143	
	Inlet Connection	mm-mm	1376×837	1376×915	1376×1008	1376×1143	1376×1233	1376×1218	1376×1368	1376×1368	1376×1418	1376×1418	1376×1518	1376×1668	1376×1818	1376×2068	
	Outlet Connection	mm	600				750				1000						
	Diverter Valve	mm	600				750				1000						
Electric	Power source	-	3PH, 400V, 50Hz														
	Absorbent Pump	kW	3.0(8.6)				4.5(12.4)				5.5(14.3)				4.5(15.2)		5.5(19.0)
	Refrigerant Pump	kW	0.4 (1.4)						1.5 (4.0)						1.8(6.0)		
	Purge Pump	kW	0.4 (1.4)						0.75(2.2)								
	Sealing Blower	kW	1.5(3.4)			2.2(5.1)											
	Control Panel	kW	0.2 (0.5)														
	Total kW	kW	5.5			6.2			7.7			9.8			9.2		10.5
	Total Ampere @ 400V	A	15.3			17.0			20.8			25.3			27.0		32.8
External Dimension	Length (L)	mm	4,872		5,414	5,912	6,012	6,537	7,037	6,114	6,639	7,139	6,749	7,249	6,966	7,466	
	Width (W)	mm	2,514	2,592	2,646	2,781	3,070	3,261		3,485	3,535		4,348	4,498	4,932	5,182	
	Height (H)	mm	2,717				2,963				3,171				3,500		3,765
Weight	Rigging	ton	15.7	16.5	21.2	23.1	24.6	27.1	32.5	33.6	35.6	41.1	43.4	46.4	50.2	54.1	
	Operation	ton	17.2	18.1	23.7	25.8	27.5	30.3	36.3	37.6	39.9	46.2	48.8	52.1	56.5	60.8	
Space tube Replacement	mm	4,600		5,200	5,700		6,300	6,700	5,700	6,300	6,700	6,300	6,700	6,300	6,700		

### Option

1. Non-standard cooling capacity.
2. Higher working pressure (230psig = 1.6MPa, 300psig = 2.0MPa)
3. Special tubes (material) & thickness.
4. Various temp. conditions (CHW, CW, HW)
5. Outdoor installation.
6. The specifications above are subject to change without prior notice for an improvement of the chiller.



# Double Effect Exhaust Gas Fired Absorption Chiller



## Performance Data

→

Model		Unit	CHP005	CHP006	CHP007	CHP008	CHP010	CHP012	CHP015	CHP018	CHP021	CHP024	CHP028	CHP032	CHP036	CHP040		
Cooling Capacity	usRT		50	60	70	80	100	120	150	180	210	240	280	320	360	400		
	kW		176	211	246	281	351	422	527	633	738	844	984	1125	1,265	1,406		
Chilled Water	Inlet/Outlet Temp.	°C	12 / 7															
	Flow rate	m <sup>3</sup> /h	30.2	36.3	42.3	48.4	60.5	72.6	90.7	109	127	145	169	194	218	242		
	Pressure Drop	mH <sub>2</sub> O	4.0	3.7	6.2	5.6	4.8	5.1	6.6	7.0	6.4	6.3	4.6	4.5	5.0	5.1		
	Connection	mm	80				100				125			150				
Cooling Water	Inlet/Outlet Temp.	°C	32 / 37.5															
	Flow rate	m <sup>3</sup> /h	50	60	70	80	100	120	150	180	210	240	280	320	360	400		
	Pressure Drop	mH <sub>2</sub> O	7.0	6.1	10.2	9.6	11.1	11.3	11.5	11.8	11.8	12.1	11.2	10.7	11.1	10.8		
	Connection	mm	100				125				150				200			
Heating Capacity	Mcal/h		142	170	198	227	283	340	425	510	595	680	793	906	1,019	1,133		
	kW		165	197	230	263	329	395	494	592	691	790	922	1,053	1,185	1,317		
Hot Water	Inlet/Outlet Temp.	°C	55.3 / 60															
	Flow rate	ton/h	30	36	42	48	60.5	72.6	90.7	109	127	145	169	194	218	242		
	Pressure Drop	mH <sub>2</sub> O	4.0	3.7	6.2	5.6	4.8	5.1	6.6	7.0	6.4	6.3	4.6	4.5	5.0	5.1		
	Connection	mm	80				100				125			150				
Exhaust Gas	Flow rate	kg/sec	0.439	0.527	0.615	0.703	0.88	1.05	1.32	1.58	1.84	2.11	2.46	2.81	3.16	3.51		
	Temp.	Cooling	450 / 165															
		Heating	450 / 125															
	Pressure Drop	mmH <sub>2</sub> O	58	58	74	71	77	82	79	92	97	113	129	131	123	131		
	Inlet Connection	mm×mm	782×291	782×330	782×369	782×408	922×408	922×486	922×603	922×642	922×681	922×681	922×798	922×876	1376×720	1376×759		
	Outlet Conn	mm	300				400				500				600			
	Diverter Valve	mm	300				400				500				600			
Electric	Power source	kW	3PH, 400V, 50Hz															
	Abs. Pump	kW [A]	1.5 (5.5)				2.0 (6.4)				2.4 (6.9)				3.2 (9.0)			
	Ref. Pump	kW [A]	0.2 (1.0)				0.3 (1.2)				0.4 (1.4)							
	Purge Pump	kW [A]	0.4 (1.4)															
	Sealing Blower	kW [A]	0.4 (2.5)															
	Control Panel	kW [A]	0.2 (0.5)															
	Amp.(400Vac)	A	10.8				11.9				12.6				14.7			
Size	Length (L)	mm	2,100		2,600		2,638		3,680		3,717		4,742		4,872			
	Width (W)	mm	1,683	1,722	1,761	1,800	1,857	1,935	2,052	2,091	2,194	2,194	2,310	2,349	2,349	2,349		
	Height (H)	mm	1800				2,090				2,147				2,399			
Weight	Rigging	ton	3.0	3.2	3.7	3.9	5.0	5.3	6.4	6.8	7.9	8.5	9.8	10.3	12.8	13.2		
	Operation	ton	3.2	3.5	4.0	4.3	5.4	5.8	7.0	7.4	8.6	9.3	10.7	11.3	14.0	14.6		

### Note

1. Working pressure of each water side is based on 1.0MPa (150psig)
2. Fouling factor 0.0001 m<sup>2</sup>.hr.°C/Kcal for Absorber, Condenser and Evaporator.
3. Min. outlet temp. of chilled water: 5°C
4. Min. allowable inlet temp. of cooling water: 20°C.
5. Controllable range shall be 0~100%.
6. Standard Power source is 3ph, 400V, 50Hz and available 220, 380, 440V and 460V power source.
7. Each water flow can be adjusted within 50~120%.

# CHP Series

## Double Effect Exhaust Gas Driven Absorption Chiller & Heater

### Performance Data

Model		Unit	CHP045	CHP050	CHP056	CHP063	CHP070	CHP080	CHP090	CHP100	CHP110	CHP120	CHP130	CHP140	CHP150		
Cooling Capacity		usRT	450	500	560	630	700	800	900	1,000	1,100	1,200	1,300	1,400	1,500		
		kW	1,582	1,757	1,968	2,214	2,460	2,812	3,163	3,515	3,866	4,218	4,569	4,921	5,272		
Chilled Water	Inlet/Outlet Temp.	°C	12 / 7														
	Flow rate	m <sup>3</sup> /h	272	302	339	381	423	484	544	605	665	726	786	847	907		
	Pressure Drop	mH <sub>2</sub> O	4.4	3.9	3.6	5.0	6.6	4.7	6.4	8.5	7.2	9.2	11.5	8.3	10.2		
	Connection	mm	200					250			300			350			
Cooling Water	Inlet/Outlet Temp.	°C	32 / 37.5														
	Flow rate	m <sup>3</sup> /h	450	500	560	630	700	800	900	1,000	1,100	1,200	1,300	1,400	1,500		
	Pressure Drop	mH <sub>2</sub> O	10.7	10.8	7.7	10.6	14.0	8.7	11.8	15.6	3.0	3.8	4.8	4.0	4.8		
	Connection	mm	250			300			350			400					
Heating Capacity		Mcal/h	1,274	1,416	1,586	1,784	1,982	2,266	2,549	2,832	3,115	3,398	3,682	3,965	4,248		
		kW	1,481	1,646	1,843	2,074	2,304	2,633	2,962	3,291	3,621	3,950	4,279	4,608	4,937		
Hot Water	Inlet/Outlet Temp.	°C	55.3 / 60														
	Flow rate	ton/h	272	302	339	381	423	484	544	605	665	726	786	847	907		
	Pressure Drop	mH <sub>2</sub> O	4.4	3.9	3.6	5.0	6.6	4.7	6.4	8.5	7.2	9.2	11.5	8.3	10.2		
	Connection	mm	200					250			300			350			
Exhaust Gas	Flow rate	kg/sec	3.95	4.39	4.92	5.53	6.15	7.03	7.91	8.78	9.66	10.54	11.42	12.30	13.18		
	Temp.	Cooling	°C 450 / 165														
		Heating	°C 450 / 125														
	Pressure Drop	mmH <sub>2</sub> O	133	134	143	133	146	155	153	176	213	221	212	206	184		
	Inlet Connection	mm×mm	1376×837	1376×915	1376×1008	1376×1143	1376×1233	1376×1218	1376×1368	1376×1418	1376×1418	1376×1518	1376×1668	1376×1818	1376×2068		
	Outlet Conn	mm	600			750						1000					
	Diverter Valve	mm	600			750						1000					
Electric	Power source	kW	3PH, 400V, 50Hz														
	Abs. Pump	kW [A]	3.2 (9.0)			5.5 (15.0)						7.5 (24.0)					
	Ref. Pump	kW [A]	0.3 (1.2)						1.5 (4.0)								
	Purge Pump	kW [A]	0.4 (1.4)						0.75 (2.2)								
	Sealing Blower	kW [A]	0.4 (2.5)														
	Control Panel	kW [A]	0.2 (0.5)														
	Total Ampere @400V	A	14.7			20.7			23.3			33.1					
Size	Length (L)	mm	4,954		4,998	5,540	6,038	5,644	6,142	6,667	6,293	6,818	7,318	6,974	7,475		
	Width (W)	mm	2,491	2,569	2,934	3,069	3,159	3,330	3,480	3,530	4,348	4,448	4,598	4,932	5,182		
	Height (H)	mm	2,633			2,962			3,380			3,500			3,700		
Weight	Rigging	ton	15.7	16.5	21.2	23.1	24.6	31.0	33.6	35.6	41.1	43.4	46.4	50.2	54.1		
	Operation	ton	17.2	18.1	23.7	25.8	27.5	34.8	37.6	39.9	46.2	48.8	52.1	56.5	60.8		





### Option

1. Non-standard cooling capacity.
2. Higher working pressure (230psig = 1.6MPa, 300psig = 2.0MPa)
3. Special tubes (material) & thickness.
4. Various temp. conditions (CHW, CW, HW)
5. Outdoor installation.
6. The specifications above are subject to change without prior notice for an improvement of the chiller.



# Double Effect Exhaust Gas Driven Absorption Chiller

## Thermal Insulation

### INSULATION FOR HOT SURFACES

-  75mm(3inch) : High Temp. Generator
-  50mm(2inch) : Steam Pippings, Box of Low Temp. Generator, Pippings of High Temp. Generator(Inlet, Outlet), Boxes of High Temp. Heat Exchanger
-  19mm(3/4inch) : Low Temp. Generator Body and Outlet Box(ABSO), High & Low Temp. Heat Exchanger Body and Box of Heat
-  10mm(3/8inch) : Inlet & Outlet Pippings of Low Temp. Generator.

### INSULATION FOR COLD SURFACES

-  19mm(3/4inch) : Evaporator Body and It's Water Box.
-  10mm(3/8inch) : Piping of Refrigerant Pump(Inlet, Outlet), Generator(Inlet, Outlet), Boxes of High Temp. Heat Exchanger

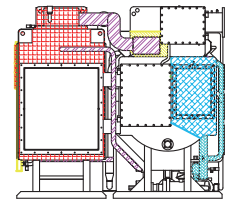
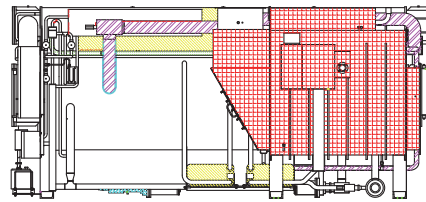
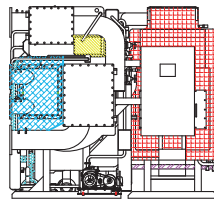
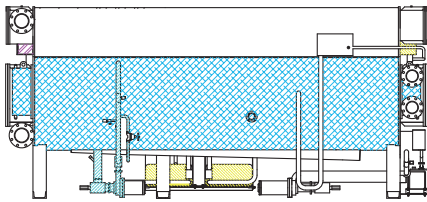
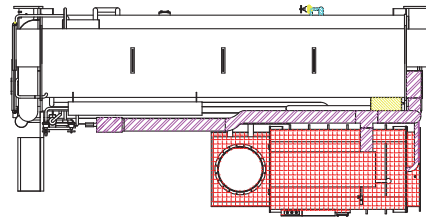

### Note

1. Use only Non-inflammable or flame retardant insulation materials.
2. Do not insulate motor of refrigerant pump.
3. Total insulation area is including pippings.
4. Do not cover components such as service valves, diaphragm valves, sight glass, control valves, thermometers or sensor.
5. Use the standard insulation material and thickness as the recommendation

### HOT Surface insulation

- Material of insulation : Glass wool, Thermal Conductivity 0.04kcal/m·h·°C
- Thickness of insulation : 50mm [2 inch], 75mm [3 inch]
- Material of insulation : Closed cell type Non-inflammable polymer sponge
- Thickness of insulation : 19mm [3/4inch], 10mm [3/8inch]

### COLD Surface insulation

- Material of insulation : Closed cell type Non-inflammable polymer sponge
- Thickness of insulation : 19mm [3/4 inch], 10mm [3/8 inch]

### Wrapping Material when Glass wool is used.

- Insulated parts on body : Colored galvanized steel with 0.45mm thickness or over
- Insulated parts on pipes : Colored galvanized steel with 0.30mm thickness or over

Model	Hot Surface (m <sup>2</sup> )				Cold Surface (m <sup>2</sup> )	
	75mm	50mm	19mm	10mm	19mm	10mm
CHP005	8.2	0.9	2.7	0.4	2.6	0.3
CHP006	8.2	0.9	2.7	0.4	2.6	0.3
CHP007	8.2	0.9	3.4	0.4	2.6	0.3
CHP008	8.2	1.1	3.4	0.4	2.6	0.3
CHP010	9.5	1.8	4.2	0.7	3.6	0.3
CHP012	10.4	1.8	4.3	0.7	3.6	0.3
CHP015	11.2	2.2	6.3	0.7	4.8	0.3
CHP018	11.4	2.2	6.3	0.7	4.8	0.3
CHP021	12.8	2.2	7.1	0.9	5.8	0.3
CHP024	13.6	2.2	7.1	0.9	5.8	0.4
CHP028	14.1	2.5	8.3	1.1	7.1	0.4
CHP032	18.2	2.5	8.3	1.1	7.1	0.4
CHP036	18.4	3.0	9.1	1.2	7.9	0.4
CHP040	18.4	3.0	9.1	1.2	7.9	0.4

Model	Hot Surface (m <sup>2</sup> )				Cold Surface (m <sup>2</sup> )	
	75mm	50mm	19mm	10mm	19mm	10mm
CHP045	20.6	3.1	10.1	1.2	7.9	0.4
CHP050	21.3	3.1	10.1	1.2	11	0.4
CHP056	23.4	7.5	11.4	1.4	13.5	0.6
CHP063	24.7	8.3	12.2	1.4	15	0.7
CHP070	25.3	9.2	13.0	1.5	16	0.7
CHP080	32.1	10.5	13.9	1.6	17	1.1
CHP090	33.7	11.5	14.4	1.6	18.5	1.2
CHP100	34.2	13.0	14.9	1.7	20	1.2
CHP110	36.5	15.5	13.7	1.7	22.2	1.4
CHP120	37.6	16.8	14.0	1.7	22.5	1.4
CHP130	39.3	18.2	14.3	1.8	23.4	1.4
CHP140	41.1	18.1	14.6	1.8	26.6	1.5
CHP150	43.9	19.6	15.1	1.8	27.6	1.5

# CHP Series

## Double Effect Exhaust Gas Driven Absorption Chiller

### Diverter Valve Installation Guide

#### Note

1. Install the diverter valve horizontally in between the exhaust duct of engine (turbine) and absorption chiller.
2. Install the connection duct between high temperature generator and diverter valve.
3. Wiring connection should be performed accordance with the wiring diagram.
4. Caution: The weight force of exhaust gas duct shouldn't be applied onto the diverter valve.

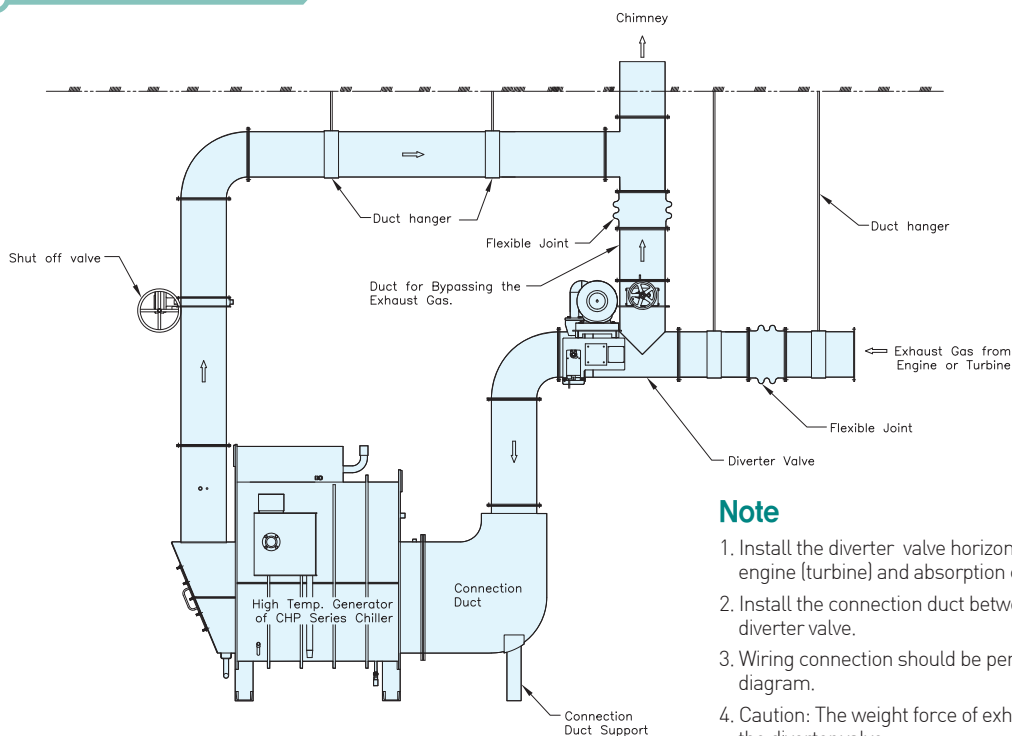
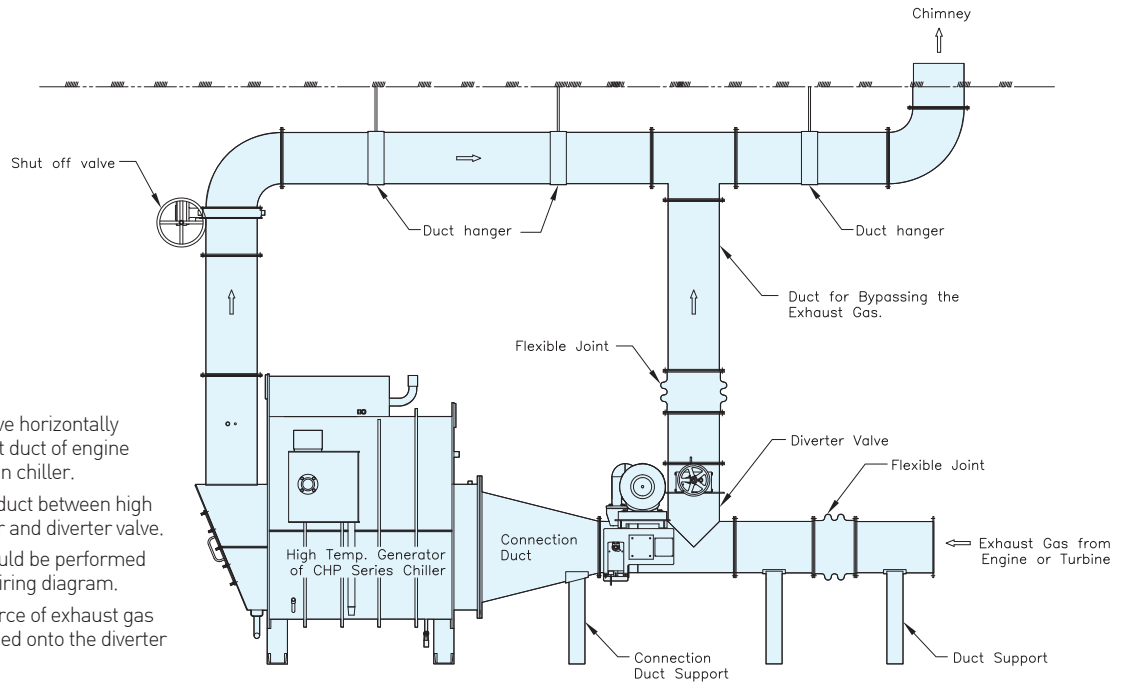

#### Note

1. Install the diverter valve horizontally in between the exhaust duct of engine (turbine) and absorption chiller.
2. Install the connection duct between high temperature generator and diverter valve.
3. Wiring connection should be performed accordance with the wiring diagram.
4. Caution: The weight force of exhaust gas duct shouldn't be applied onto the diverter valve.

# Hybrid Absorption Chiller



## CHPL Series\_Hybrid Type

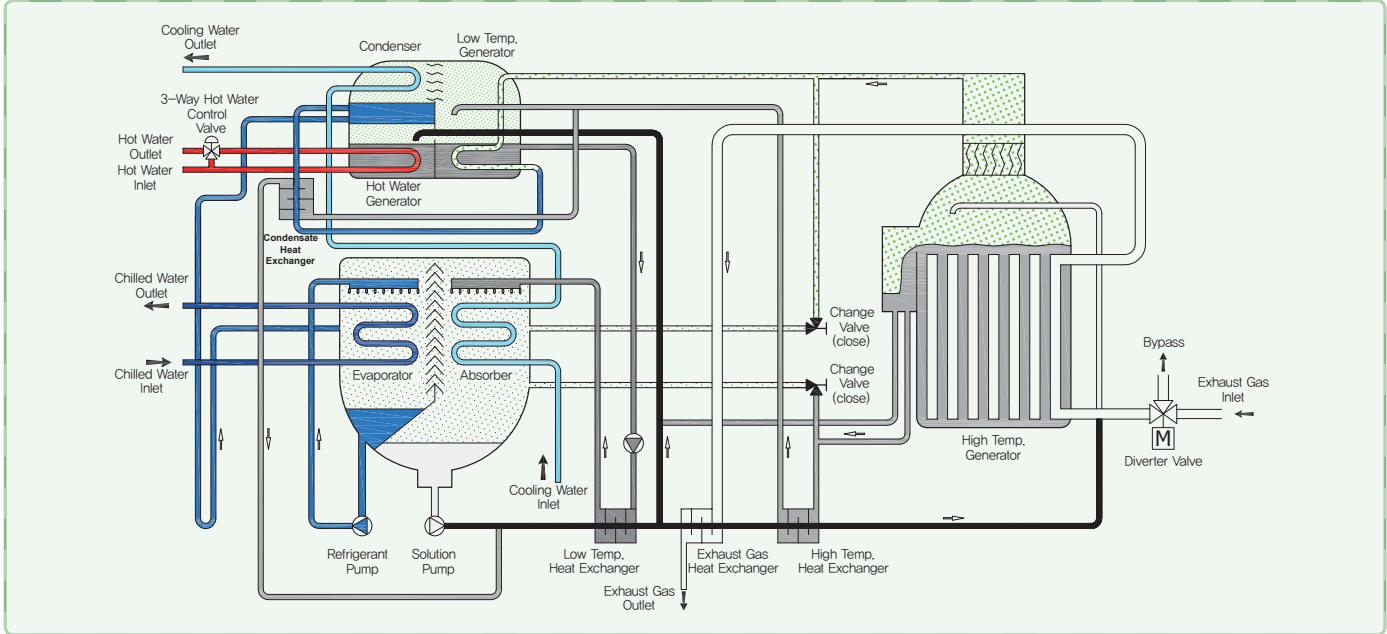

## Performance Data

Model	Unit	CHPL045H	CHPL050H	CHPL056H	CHPL063H	CHPL070H	CHPL080H	CHPL090H	
Cooling Capacity	usRT	374	416	466	524	582	666	749	
	kW	1,315	1,463	1,639	1,843	2,046	2,342	2,634	
Chilled Water	Temp.	12 / 7							
	Flow rate	m <sup>3</sup> /h	226	252	282	317	352	403	453
	Pressure Drop	mH <sub>2</sub> O	3.7	4.2	4.6	4.6	6.9	4.9	5.2
	Connection	mm	200	200	200	200	200	250	250
Cooling Water	Temp.	32 / 37.5							
	Flow rate	m <sup>3</sup> /h	395	439	492	553	614	703	790
	Pressure Drop	mH <sub>2</sub> O	6.4	7.1	7.4	8.7	12.6	7.5	8.2
	Connection	mm	250	250	250	250	300	300	300
Exhaust Gas Side	Temperature	450 / 120							
	Flow rate	ton/h	5,989	6,655	7,468	8,404	9,316	10,672	12,003
	Pressure Drop	mH <sub>2</sub> O	66	50	52	30	42	43	50
	Diverter Valve	mm	400	400	500	500	500	600	600
Hot Water Side	Temperature	90 / 80							
	Flow rate	m <sup>3</sup> /h	51.3	57.2	63.8	71.7	99.7	91.2	102.6
	Pressure Drop	mH <sub>2</sub> O	1.4	2.4	4.4	2.7	3.7	1.4	2.2
	Connection	mm	80	80	100	100	125	125	125
Elec. Power	Power Source	3PH/380V/50Hz							
	Consumption	kW	5.4	5.9	6.3	7.4	7.4	8.5	5.4
	Total Ampere @380V	A	19.4	21.2	22.4	24.6	24.6	26.7	29.7
Size	Length (L)	mm	4,876	4,876	5,213	5,534	6,032	5,644	6,032
	Width (W)	mm	2,570	2,670	2,726	2,726	2,799	3,188	3,188
	Height (H)	mm	2,657	2,657	2,860	2,860	2,860	3,380	3,380
Weight	Rigging	Ton	16.3	18.2	20.3	24.5	26.1	33.1	35.2
	Operation	Ton	14.9	16.9	18.9	21.9	23.4	29.5	33.5

# CHPL Series

## Double Effect Hybrid (Exhaust Gas + Hot Water) Absorption Chiller

### Performance Data

Model		Unit	CHPL100H	CHPL110H	CHPL120H	CHPL130H	CHPL140H	CHPL150H
Cooling Capacity		usRT	832	915	998	1,082	1,165	1,248
		kW	2,926	3,217	3,509	3,805	4,096	4,388
Chilled Water	Temp.	°C	12 / 7					
	Flow rate	m <sup>3</sup> /h	503	552	604	654	705	755
	Pressure Drop	mH <sub>2</sub> O	8.0	8.3	8.0	7.3	7.8	8.2
	Connection	mm	250	250	300	300	200	300
Cooling Water	Temp.	°C	32 / 37.5					
	Flow rate	m <sup>3</sup> /h	878	965	1053	1142	1229	1317
	Pressure Drop	mH <sub>2</sub> O	8.9	9.2	10.0	13.7	11.3	10.5
	Connection	mm	350	350	400	400	400	400
Exhaust Gas Side	Temperature	°C	450 / 120					
	Flow rate	ton/h	12,934	14,225	15,516	16,807	18,098	19,389
	Pressure Drop	mH <sub>2</sub> O	97	90	87	85	100	110
	Diverter Valve	mm	600	600	600	600	750	750
Hot Water Side	Temperature	°C	90 / 80					
	Flow rate	m <sup>3</sup> /h	142.2	125.3	136.7	185.2	159.8	171.1
	Pressure Drop	mH <sub>2</sub> O	2.8	3.2	4.3	3.7	3.8	2.7
	Connection	mm	125	80	150	150	80	150
Elec. Power	Power Source	-	3PH/380V/50Hz					
	Consumption	kW	8.5	12.4	14.5	14.5	15.0	16.0
	Total Ampere @380V	A	26.7	32.4	46.2	46.2	51.3	56.6
Size	Length (L)	mm	5,644	6,212	6,818	7,318	7,318	7,475
	Width (W)	mm	3,188	3,840	4,161	4,411	4,834	5,182
	Height (H)	mm	3,380	3,380	3,500	3,500	3,600	3,700
Weight	Rigging	Ton	33.1	36.7	46.4	49.5	52.8	57.8
	Operation	Ton	29.5	31.5	41.2	44.1	49.7	51.4

### Note

- Working pressure of each water side is based on 1.0MPa (150psig)
- Fouling factor 0.0001 m<sup>2</sup>.hr.°C/Kcal for Absorber, Condenser and Evaporator.
- Min. outlet temp. of chilled water: 5°C
- Min. allowable inlet temp. of cooling water: 20°C.
- Controllable range shall be 0~100%.
- Available power sources (options): 220V, 380V, 440V and 460V with 50Hz or 60Hz.
- Custom design is available with modifications of the standard specification
  - Cooling capacity
  - Chilled and Cooling water circuit with anti-freezing additives
  - Higher working pressure
  - Special tubes and thicker shell material
  - Various operational temp. conditions (CHW or/and CW)
  - Higher delta-T operation
  - Outdoor installation
- The specifications above are subject to change without prior notice for an improvement of the chiller.



# Absorption Heat Pump

## HPS Series\_Steam Driven Type

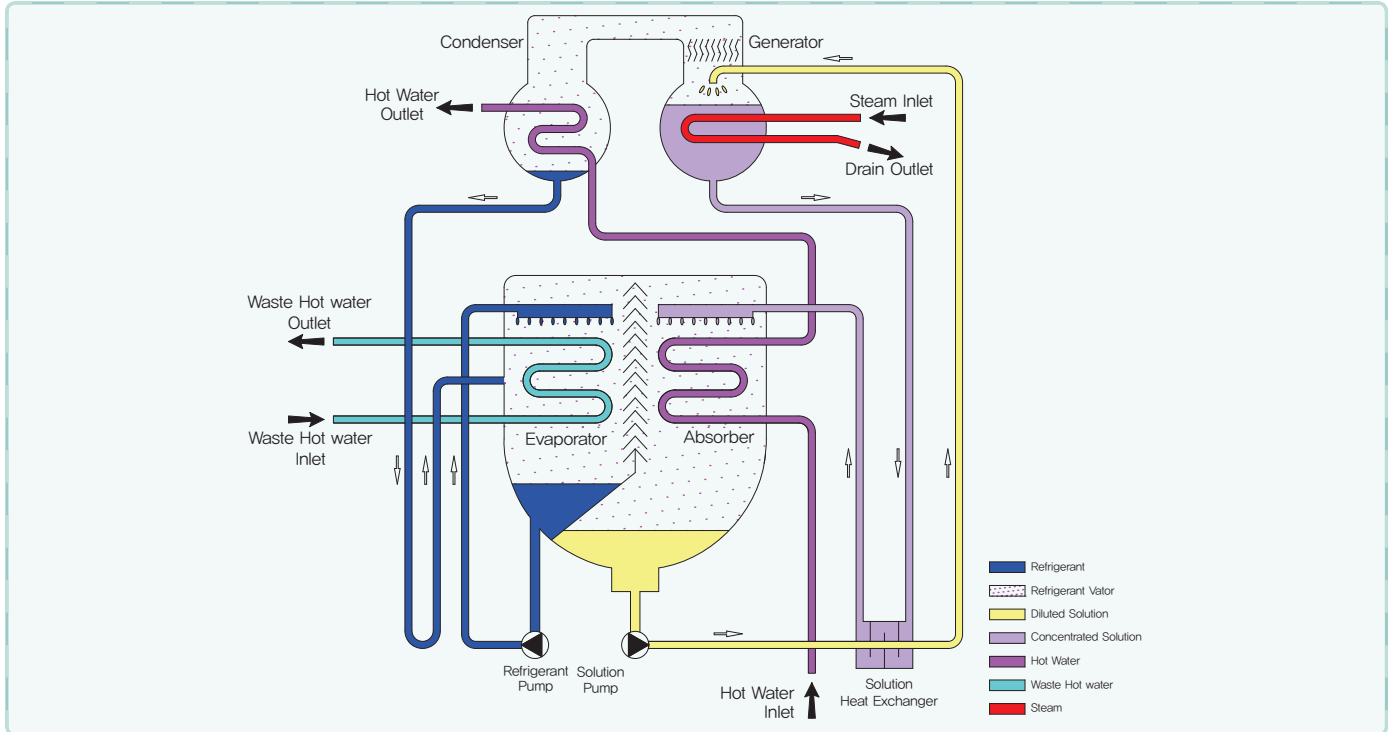

## HPD Series\_Direct Fired Type

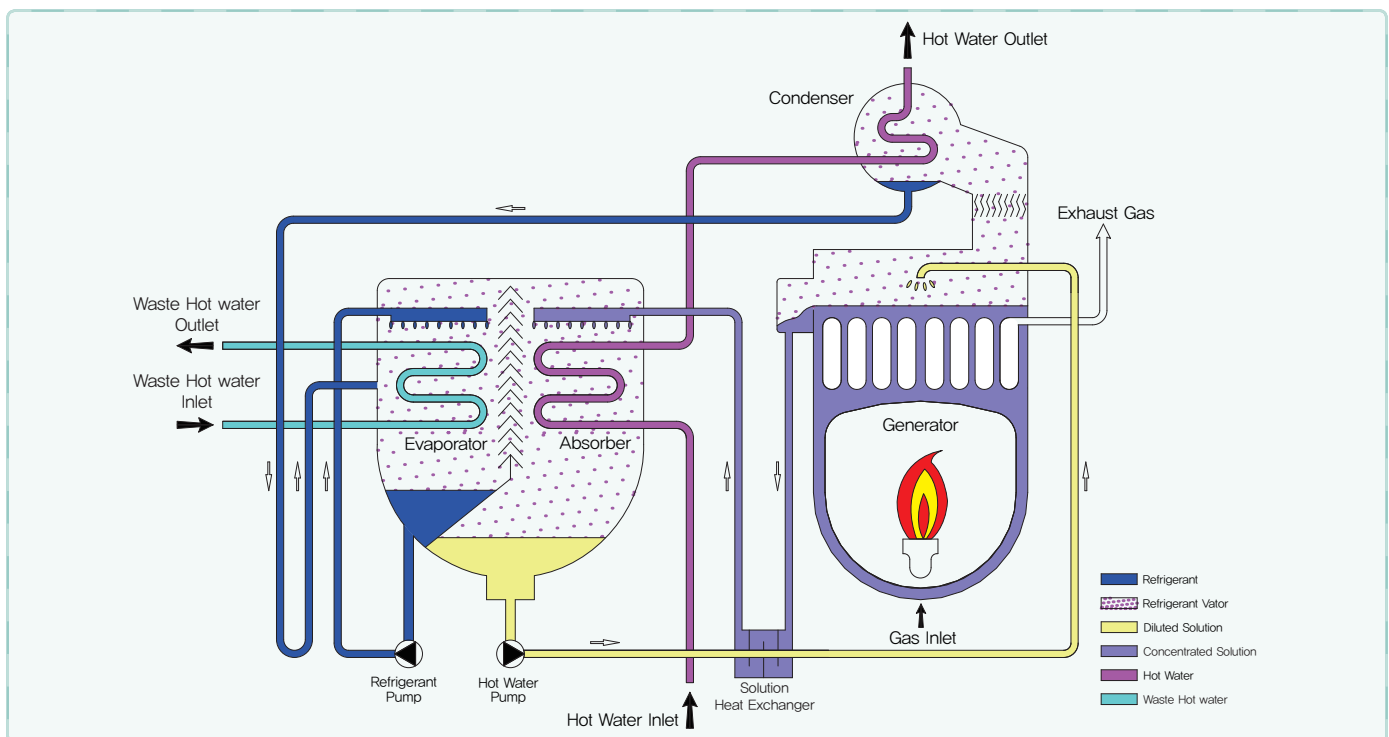

AHT Series\_Steam Generation Type

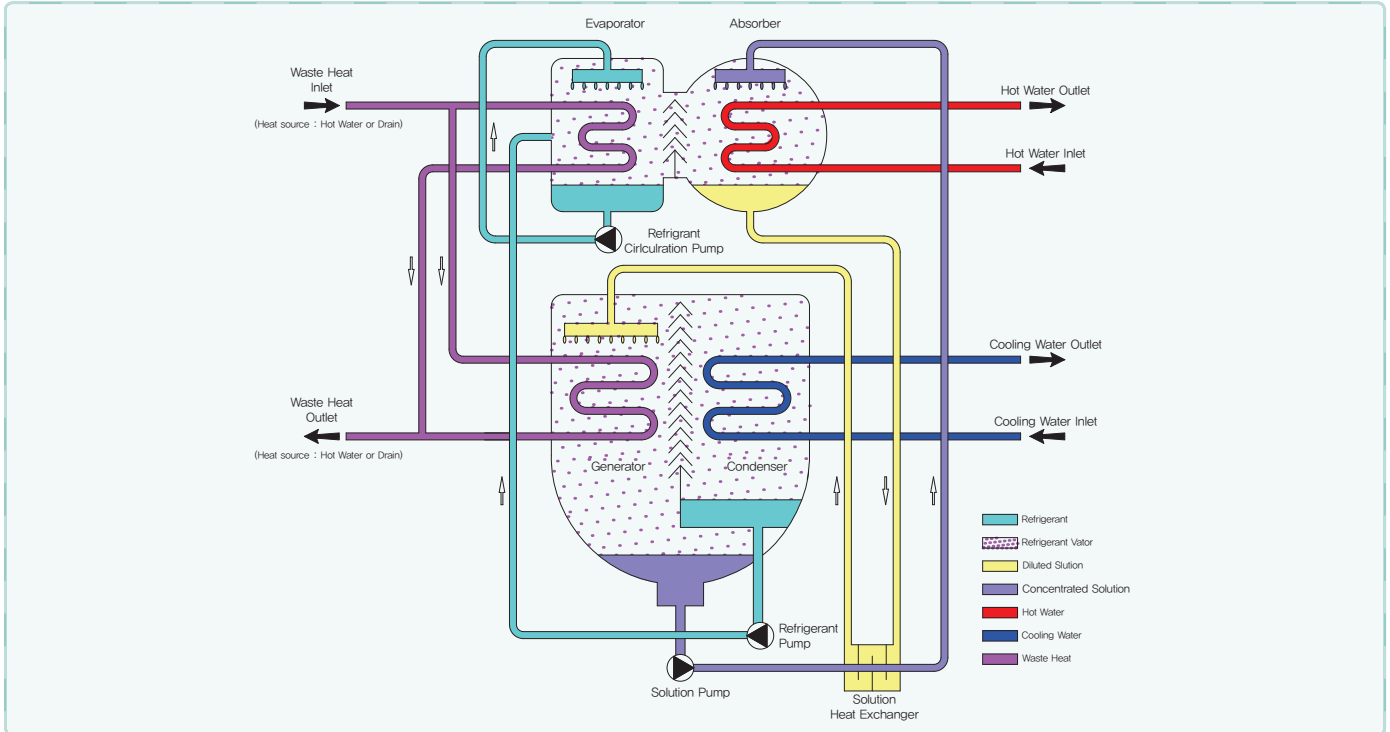

H2A Series\_2-Lift Type

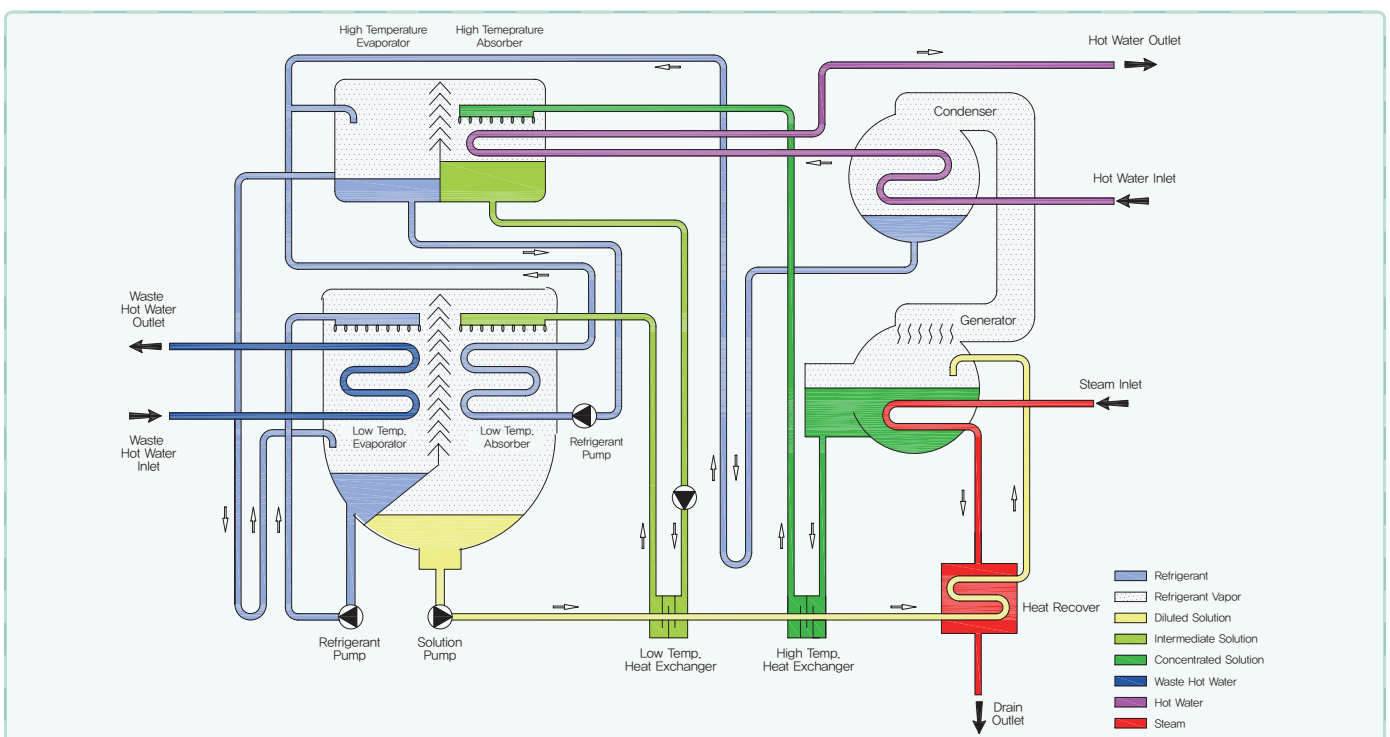

# Absorption Heat Pump

## Performance Data

### • HPS Series

### Steam Fired Type Absorption Heat Pump (670 ~ 4686kW)

Model		Unit	HPS010	HPS012	HPS015	HPS018	HPS021	HPS024	HPS028	HPS032	HPS036	HPS040	HPS045	HPS050	HPS056	HPS063	HPS070
Heating capacity		Mcal/h	576	691	864	1,036	1,209	1,382	1,612	1,842	2,073	2,303	2,591	2,879	3,224	3,627	4,030
Hot Water	Inlet/Outlet Temp.	°C	20 / 80														
	Flow rate	ton/h	9.6	11.5	14.4	17.3	20.2	23.0	26.9	30.7	34.5	38.4	43.2	48.0	53.7	60.5	67.2
	Pressure Drop	mH <sub>2</sub> O	3.6	3.7	9.8	10.0	9.4	9.9	8.9	9.4	9.4	9.0	9.4	9.3	3.0	4.1	5.4
	Connection	mm	65A					80A					100A				
Recovery Heat Capacity		Mcal/h	227	272	340	408	476	544	635	726	816	907	1,021	1,134	1,270	1,429	1,588
Waste Hot Water	Inlet/Outlet Temp.	°C	30 / 20														
	Flow rate	m <sup>3</sup> /h	22.7	27.2	34.0	40.8	47.6	54.4	63.5	72.6	81.6	90.7	102.1	113.4	127.0	142.9	158.8
	Pressure Drop	mH <sub>2</sub> O	10.7	10.8	10.7	11.3	9.9	10.6	10.5	11.0	11.1	12.0	10.6	11.0	10.3	13.9	14.8
	Connection	A	80A					100A					125A				
Steam side	Flow rate	kg/h	622.5	747.0	933.8	1120.5	1307.3	1494.0	1743.0	1992.0	2241.0	2490.0	2801.3	3112.5	3486.0	3921.8	4357.5
	Inlet Connection	mm	80					100					125				
	Drain Connection	mm	25					40					50				
	Valve Connection	mm	40			40			50			65			80		
Electric	Power source	-	3PH, 400V, 50Hz														
	Absb. Pump	kW [A]	1.5 [5.4]			3.0 [7.5]			3.4 [10.2]			5.5 [15.0]					
	Ref. Pump	kW [A]	0.3 [1.5]					0.4 [1.6]					1.5 [4]				
	Purge Pump	kW [A]	0.4 [1.0]														
	Control Panel	kW [A]	0.3 [0.5]														
	Total Ampere @400V	A	8.4			10.5			13.3			20.5					
Size	Length (L)	mm	2,436			3,456			3,506			4,526			4,606		
	Width (W)	mm	1,335					1,495					1,558		1,689		
	Height (H)	mm	1,980					2,370					2,700				
Weight	Rigging	ton	3.3	3.4	4.1	4.3	5.2	5.5	6.2	6.6	7.9	8.5	10.0	10.4	14.4	15.6	16.4
	Operation	ton	4.5	4.8	5.8	6.2	7.5	8.0	9.0	9.7	11.5	12.3	14.5	15.2	20.0	21.8	23.1
	Max. Shipping	ton	3.3	3.4	4.1	4.3	5.2	5.5	6.2	6.6	7.9	8.5	10.0	10.4	12.4	13.4	14.0
	Shipment Type	-	One Body												Two Body		
Space for Tube Replacement		mm	2,400			3,400			4,500			5,200			5,700		

### • HPD Series

### Steam Fired Type Absorption Heat Pump (670 ~ 4686kW)

Model		Unit	HPD010	HPD012	HPD015	HPD018	HPD021	HPD024	HPD028	HPD032	HPD036	HPD040	HPD045	HPD050	HPD056	HPD063	HPD070			
Hot Water Outlet capacity		Mcal/h	576	691	864	1,036	1,209	1,382	1,612	1,842	2,073	2,303	2,591	2,879	3,224	3,627	4,030			
Hot Water	Inlet/Outlet Temp.	°C	20 / 80																	
	Flow rate	ton/h	9.6	11.5	14.4	17.3	20.2	23.0	26.9	30.7	34.5	38.4	43.2	48.0	53.7	60.5	67.2			
	Pressure Drop	mH <sub>2</sub> O	3.6	3.7	9.8	10.0	9.4	9.9	8.9	9.4	9.4	9.0	9.4	9.3	3.0	4.1	5.4			
	Connection	mm	65A					80A					100A							
Waste Heat Capacity		Mcal/h	227	272	340	408	476	544	635	726	816	907	1,021	1,134	1,270	1,429	1,588			
Waste Water	Inlet/Outlet Temp.	°C	30 / 20																	
	Flow rate	m <sup>3</sup> /h	22.7	27.2	34.0	40.8	47.6	54.4	63.5	72.6	81.6	90.7	102.1	113.4	127.0	142.9	158.8			
	Pressure Drop	mH <sub>2</sub> O	10.7	10.8	10.7	11.3	9.9	10.6	10.5	11.0	11.1	12.0	10.6	11.0	10.3	13.9	14.8			
	Connection	mm	80A					100A					125A							
fuel consumption	LNG(10,500kcal/Nm <sup>3</sup> )	Nm <sup>3</sup> /h	40.0	48.0	60.1	72.1	84.1	96.1	112.1	128.1	144.1	160.1	180.2	200.2	224.2	252.2	280.3			
	LPG(12,000kcal/kg)	kg/h	35.0	42.0	52.5	63.1	73.6	84.1	96.1	112.1	126.1	140.1	157.6	175.2	196.2	220.7	245.2			
	Supply pressure	mmH <sub>2</sub> O	4,000																	
	Gas connection	A	40A					50A												
	Kerosene(10,960kcal/l)	l/h	39.3	47.2	59.0	70.7	82.5	94.3	110.1	125.8	141.5	157.2	176.9	196.5	220.1	247.6	275.1			
	Diesel(11,100kcal/l)	l/h	38.8	46.6	58.2	69.9	81.5	93.1	106.7	124.2	139.7	155.2	174.6	194.0	217.3	244.5	271.7			
Electric	Oil Connection	A	15A x 2										20A x 2							
	Power source	-	3PH, 400V, 50Hz																	
	Absb. Pump	kW [A]	1.5 [5.4]			3.0 [7.5]			3.4 [10.2]			5.5 [15.0]								
	Ref. Pump	kW [A]	0.3 [1.5]					0.4 [1.6]					1.5 [4]							
	Gas Burner	kW [A]	1.5 [3.5]			2.2 [5.0]			3.7 [8.1]			4.0 [10.5]			7.5 [18.6]					
	Oil Burner	kW [A]	1.5 [3.5]		2.2 [5.0]		3.7 [8.1]		6.3 [13.1]						8.6 [21.9]					
Size	Purge Pump	kW [A]	0.4 [1.0]																	
	Control Panel	kW [A]	0.3 [0.5]																	
	Total Ampere @400V	A	11.9/11.9	11.9/13.4	14.0/15.5	15.5/23.1	15.5/23.1	21.4/26.4			23.8/26.4			31.9/35.2			39.1/42.4			
	Length (L)	mm	2,643	2,843	3,456			3,645			4,526			4,606			4,666	5,206	5,706	
Width (W)	mm	1,980			2,370			2,315	2,461	0	2,557	2,590	2,819	2,965		3,263				
Height (H)	mm	1,930					2,370					2,700					3,100			
Weight	Rigging	ton	4.0	4.1	4.9	5.3	6.5	6.9	7.9	8.6	10.3	10.8	12.6	13.3	19.0	20.6	21.8			
	Operation	ton	5.2	5.5	6.6	7.3	8.7	9.3	10.7	11.7	13.9	14.6	17.1	18.1	24.6	26.8	28.5			
	Max. Shipping	ton	4.0	4.1	4.9	5.3	6.5	6.9	7.9	8.6	10.3	10.8	12.6	13.3	12.4	13.4	14.0			
	Shipment Type	-	One Body												Two Body					
Exhaust Duct		mm	280x210			310x310			360x310			410x310			350x350			400x620		
Space for Tube Replacement		mm	2,400			3,400			4,500			5,200			5,700					

# HPS, HPD, AHT, H2A Series

## Absorption Heat Pump

### Performance Data

#### • AHT Series

#### Steam Fired Type Absorption Heat Pump (670 ~ 4686kW)

Model		Unit	AHT-560	AHT-1100	AHT-1650	AHT-2200	AHT-2250	AHT-3300	AHT-3800	
Hot Water	Heating Capacity	kcal/h	300,000	600,000	900,000	1,200,000	1,500,000	1,800,000	2,100,000	
	flow rate	ton	50	100	150	200	250	300	350	
	Inlet Temp.	°C	127	127	127	127	127	127	127	
	Outlet Temp.	°C	133	133	133	133	133	133	133	
	Pressure Drop	mH <sub>2</sub> O	5	5	5	5	5	5	5	
	Connection	A	100	125	150	200	200	200	250	
	Max. Working Pressure	kg/cm <sup>2</sup> G	3.5	3.5	3.5	3.5	3.5	3.5	3.5	
Waste Steam	Waste Heat Capacity	kcal/h	625,000	1,250,000	1,875,000	2,500,000	3,125,000	3,750,000	4,375,000	
	Temp.	°C	88	88	88	88	88	88	88	
	Connection	A	150	200	200	250	250	300	300	
	Drain Connection	A	50	80	100	125	125	125	150	
	Max. Working Pre	kg/cm <sup>2</sup> G	2	2	2	2	2	2	2	
Cooling Water	Flow rate	ton/h	54	108	162	216	270	324	378	
	Inlet Temp.	°C	26	26	26	26	26	26	26	
	Outlet Temp.	°C	32	32	32	32	32	32	32	
	Pressure Drop	mH <sub>2</sub> O	7	7	7	7	7	7	7	
	Connection	A	100	125	150	200	200	250	250	
	Condition	—	Industrial Water							
	Max. Working	kg/cm <sup>2</sup> G	4.5	4.5	4.5	4.5	4.5	4.5	4.5	
Electric	Power source	—	3PH, 400V, 50Hz							
	Abs. Pump	kw(A)	1.5	2.2	3.7	3.7	5.5	5.5	5.5	
	Ref. Pump-1	kw(A)	0.75	0.75	0.75	0.75	0.75	0.75	0.75	
	Ref. Pump-2	kw(A)	0.75	0.75	0.75	0.75	0.75	1.5	1.5	
	Purge Pump	kw(A)	0.4	0.4	0.4	0.75	0.75	0.75	0.75	
	Control Panel	kw(A)	300	300	300	300	300	300	300	
Size	Length (L)	mm	4,470	4,645	4,680	6,870	6,870	7,150	7,735	
	Width (W)	mm	2,405	3,005	3,260	3,240	3,310	3,585	4,000	
	Height (H)	mm	4,300	4,615	5,010	5,120	5,370	5,770	5,430	
Operation	ton	16	27	36	48	52	59	63		

#### • H2A Series

#### 2-Lift Type Absorption Heat Pump

Model		Unit	H2A-100	H2A-200	H2A-300
Heating capacity		kW	1,000	2,000	3,000
		Mcal/h	860	1,720	2,580
Hot Water	Inlet/ Outlet Temp.	°C	50/ 70		
	Flow rate	m <sup>3</sup> /h	43.6	87.1	130.7
	Pressure Drop	mH <sub>2</sub> O	-	-	-
	Connection	mm	100A	125A	150A
Waste Hot Water	Inlet/ Outlet Temp.	°C	15/ 10		
	Flow rate	m <sup>3</sup> /h	41.3	82.5	123.8
	Pressure Drop	mH <sub>2</sub> O	-	-	-
	Connection	mm	100A	125A	150A
Steam Side	Steam Pressure	MPa(g)	0.3		
	Steam Flow rate	kg/h	1,168	2,337	3,505
	Steam Connection	mm	80A	125A	200A
	Drain Connection	mm	40A	50A	65A
	Control Valve	mm	65A	100A	125A
Electric	Power Source	-	3PH, 380V, 60Hz		
	Absb. Pump (Diluted)	kW(A)	1.2(4.0)	2.4(7.0)	3.0(11.0)
	Absb. Pump (Concentrated)	kW(A)	0.4(1.6)	1.2(4.0)	1.5(4.0)
	High Temp. Ref. Pump	kW(A)	1.5(4.0)	3.0(5.8)	4.0(12.0)
	Low Temp. Ref. Pump	kW(A)	0.3(1.5)	0.4(1.6)	0.4(1.6)
	Purge Pump	kW	0.4(1.5)		
	Control Panel	kW	0.2(0.5)		
	Total kW	kW	4.0	7.6	9.5
	Total Ampere	A	13.1	20.4	30.6
	Size	Length (L)	mm	3,720	4,876
Width (W)		mm	1,389	1,495	1,594
Height (H)		mm	2,257	2,832	3,174
Weight	Rigging	ton	7.1	10.9	17.2
	Operation	ton	8.4	13.1	20.8
Space for Tube Replacement.	mm	3,400	4,500	5,700	

## Water Quality / Scope of Supply / Painting

### Cooling Water Quality Control

The cooling water which is recycled by cooling tower is exposed into atmosphere and polluted as it is vaporized. If the cooling water gets polluted, it develops corrosion and also scale inside the tubes and absorption machine performance drops.

Therefore, it is recommended to control the water quality; the following table shows guideline for cooling water and make-up water. The tube cleaning method and interval depends on each water quality.

	Items	Cooling Water	Make-up Water	Tendency	
				Corrosion	Scale
Standard	PH (25°C)	6.5 ~ 8.0	6.5 ~ 8.0	○	○
	Conductivity (25°C, $\mu\text{S}/\text{cm}$ )	Max. 800	Max. 200	○	○
	Chloride ion Cl (mg / cl / ℓ)	Max. 200	Max. 50	○	
	Sulfuric acid ion $\text{SO}_4^{2-}$ (mg $\text{CaCO}_3$ / ℓ)	Max. 200	Max. 50	○	
	Alkalinity pH4.8 (mg $\text{CaCO}_3$ / ℓ)	Max. 100	Max. 50		○
	Total hardness (mg $\text{CaCO}_3$ / ℓ)	Max. 200	Max. 50		○
Reference	Iron Fe (25°C)	Max. 1.0	Max. 0.3	○	
	Sulfides $\text{S}^{2-}$ ion (ms $\text{S}^{2-}$ / ℓ)	No trace	No trace	○	
	Ammonium ion $\text{NH}_4^+$ (mg $\text{NH}_4^+$ / ℓ)	Max. 1.0	Max. 0.2	○	
	Silica $\text{SiO}_2$ (mg $\text{SiO}_2$ / ℓ)	Max. 50	Max. 30		○

### Supply Scope (Standard)

Item	Description	Scope
Chiller Assembly	1) Evaporator, Absorber, Condenser, Generators 2) Solution Heat Exchanger 3) Pumps - Solution pumps with isolation valves - Refrigerant pump with isolation valves - Purge pump 4) Control panel - Panel unit, Circuit Breakers - Switches ( Operation, emergency, man/auto selector) - Relays, Controller, Touch screen 5) Locally mounted control instruments - Flow switch or D.P. switch - Temperature Sensors 6) Purge Unit - Storage tank, Manometer, Purge pump, Liquid trap, Diaphragm valves and PD cell(Optional) 7) Interconnecting piping and wiring - Refrigerant and absorbent piping for internal mechanical components - Control & Power wiring for Internal electrical components	Vendor
Initial charge	Absorbent (Lithium bromide) with inhibitor Refrigerant (demineralized water), N-alcohol	Vendor
Painting	Painting for chiller assembly and control panel	Vendor
Insulation	Insulation on hot surface and cold surface of Absorption chiller	Option
Test & Inspection	1) Check of external dimensions 2) Hydraulic Pressure test for water Boxes 3) Leak Test (Vacuum side) 4) Function test for electric circuit and safety device	Vendor
Performance Test	Factory performance test, Commissioning & Start-up	Option
Installation	1. Foundation 2. Installation 3. External piping and wiring 4. Interlock wiring of chilled water pump and cooling water pump. 5. Installation and wiring of control valve.	Buyer

### Painting

- Painting type : Prime and Epoxy Finish painting
- Color : Chiller body - Blue (Munsell No. 4.0 PB3.4/6.7)  
Control Panel - Grey (Munsell No.5Y 7/1)

# Controls

## Control Panel

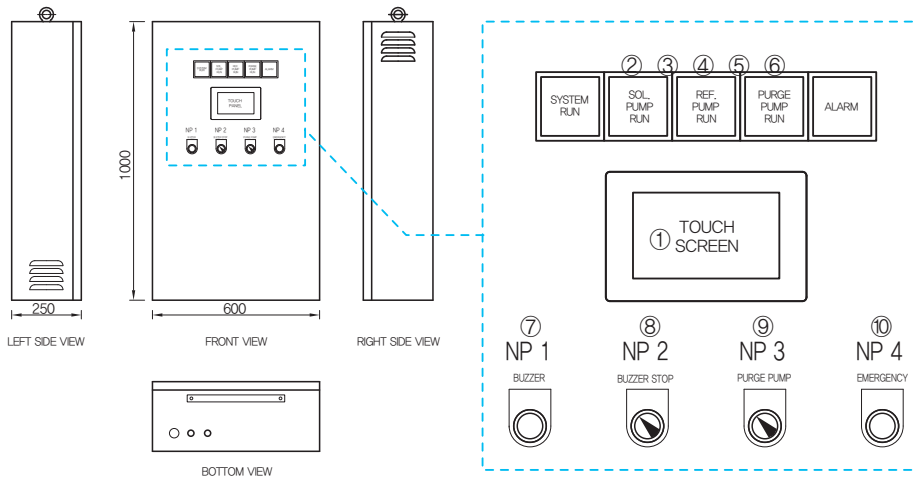

Number	Model
①	Touch Screen
②	Chiller operating lamp
③	Solution pump operating lamp
④	Refrigerant pump operating lamp
⑤	Purge pump operating lamp
⑥	Alarm lamp
⑦	Buzzer
⑧	Buzzer stop switch
⑨	Purge pump ON/OFF switch
⑩	Emergency switch

## User Interface Wiring

Vendor scope ← Buyer scope

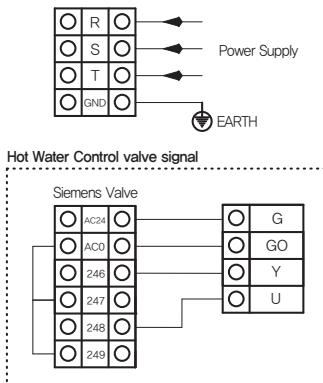

Refer to the provided User Interface Wiring manual for each project.

Vendor scope ← Buyer scope

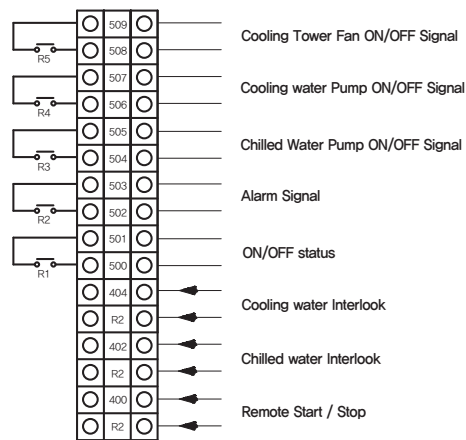

## Chiller Control

### (1) SIEMENS Controller



#### SIEMENS Controller POL635/638

- Power : 24VDC
- IO Quantity
  - Binary Output : 6 ea
  - Analog Output : 4 ea
  - Relay Inputs : 5 ea
  - Universal Inputs : 2 ea
  - Universal IO : 6 ea
- Feature
  - The controller can be connected to extension I/O modules.
- Communication: RS-485



#### SIEMENS Controller POL955

- Extension I/O module. Use when the main controller's I/O connections are not enough.
- Extension I/O modules can be attached up to 31 units at most.
- IO Quantity
  - Relay Output : 4ea
  - Analog Output : 2ea
  - Universal IO : 8ea

### (2) Touch Screen



- Power : 24Vdc
- Communication : RS-232, RS-485
- Display : 7" TFT Color
- Colors : 65,536



# Controls

## Function

(1) You can have the overview of the chiller's data and easily start/stop the operation.

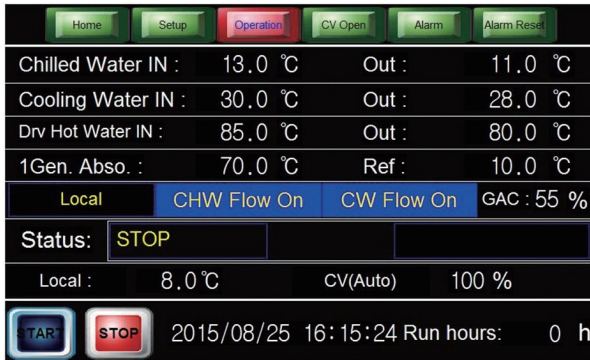

(2) It provides 4 kinds of operation modes to choose : Local, Shedule, Remote, Internet.

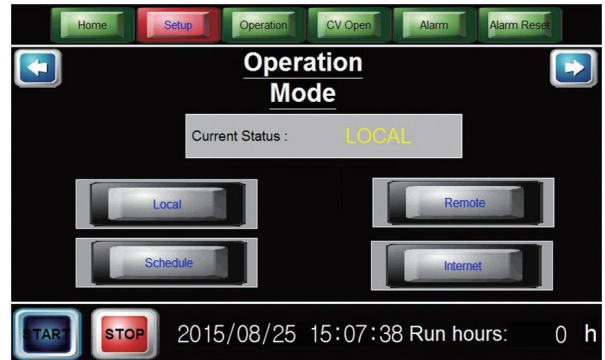

(3) You can see the chart of the chilled water inlet/outlet temperature.

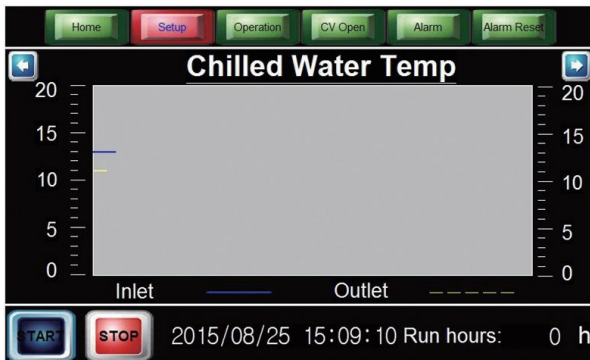

(4) It supports Korean & English. The language can be added upon the customer's request.



(5) In the 'Schedule' operation mode, you can set the start/stop time on a weekly basis.

	In	Start Time	Stop Time	Out
S	NO	0 : 0	0 : 0	OFF
M	NO	0 : 0	0 : 0	OFF
T	NO	0 : 0	0 : 0	OFF
W	NO	0 : 0	0 : 0	OFF
T	NO	0 : 0	0 : 0	OFF
F	NO	0 : 0	0 : 0	OFF
S	NO	0 : 0	0 : 0	OFF

(6) You can check the alarm status.

Date Time	Alarm Status	Reset Time
2015/08/25 15:05	Cooling water Low flow	
2015/08/25 15:02	Cooling water Low flow	2015/08/25 15:05
2015/08/25 15:02	Cooling water Low flow	2015/08/25 15:02
2015/08/25 15:00	Emergency Stop	
2015/08/25 15:00	Hot Water Inlet Temp. High	
2015/08/25 15:00	1st Gen. Absorbent Temp. High	
2015/08/25 15:00	1st Gen. absorbent temp. sensor	

TAR STOP 2015/08/25 15:26:55 Run hours: 0 h

# Controls

## Communication Specification

(1) MODBUS-RTU

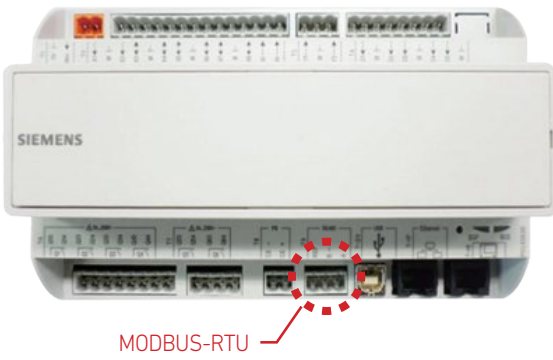

(2) MODBUS-TCP

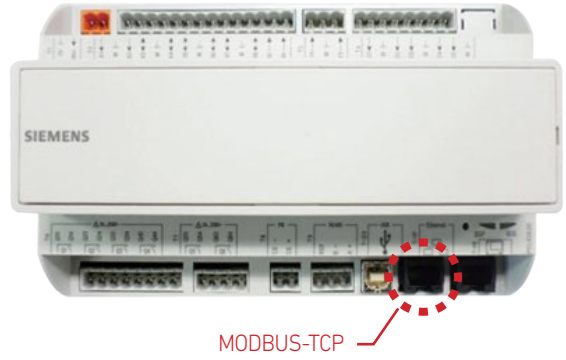

(3) PROFIBUS



(4) BACnet



(5) INETNET

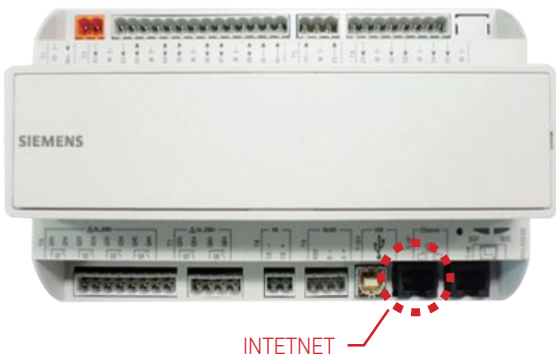

(6) MMI(SCADA SYSTEM)



# Controls

## Communication Protocol

### (1) MODBUS-RTU

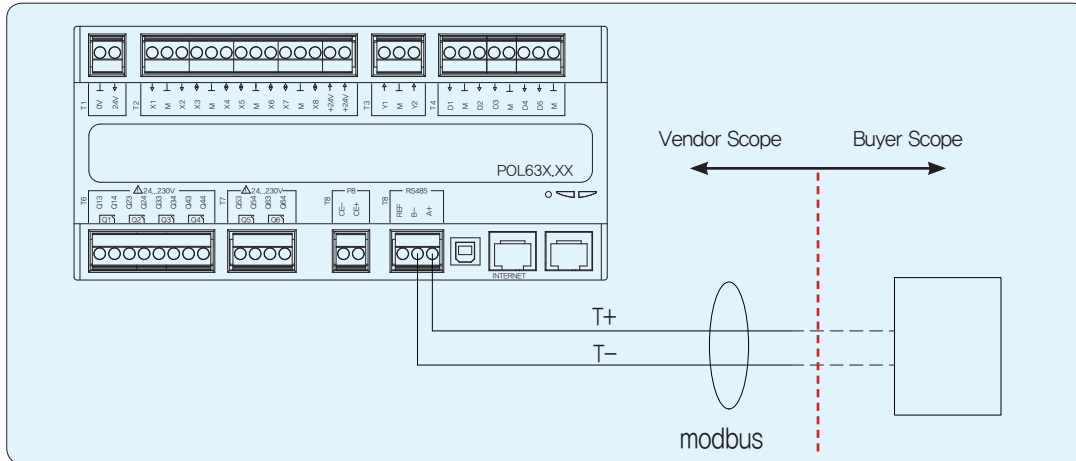

### (2) MODBUS-TCP

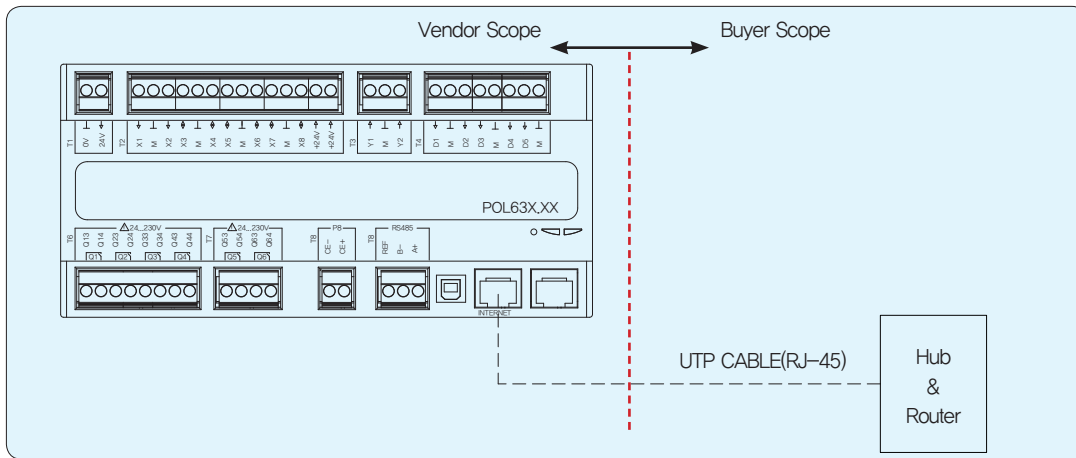

**Caution**  
Use "Direct Cable" for UTP CABLE(RJ-45) if you use a hub or a router (line sharer). If not, use "Cross Cable".

### (3) PROFIBUS

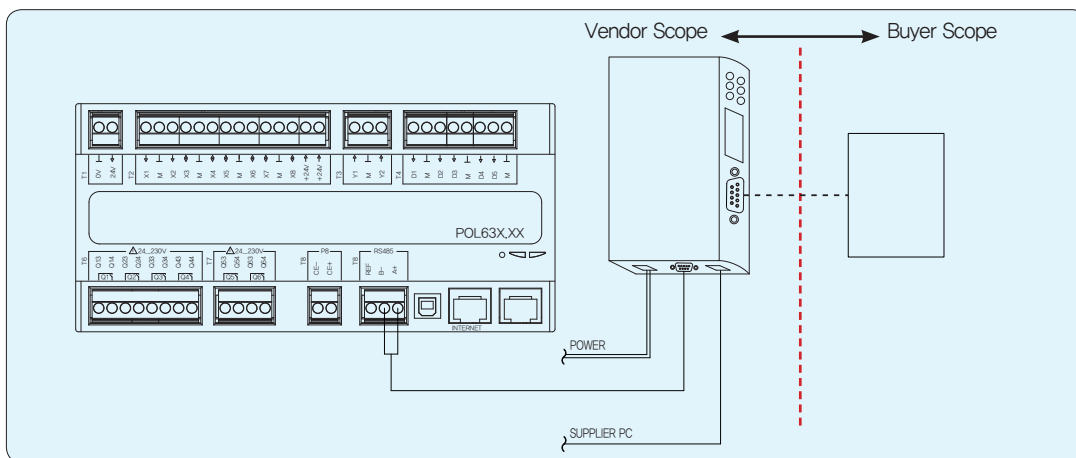

# Controls

## (4) BACnet

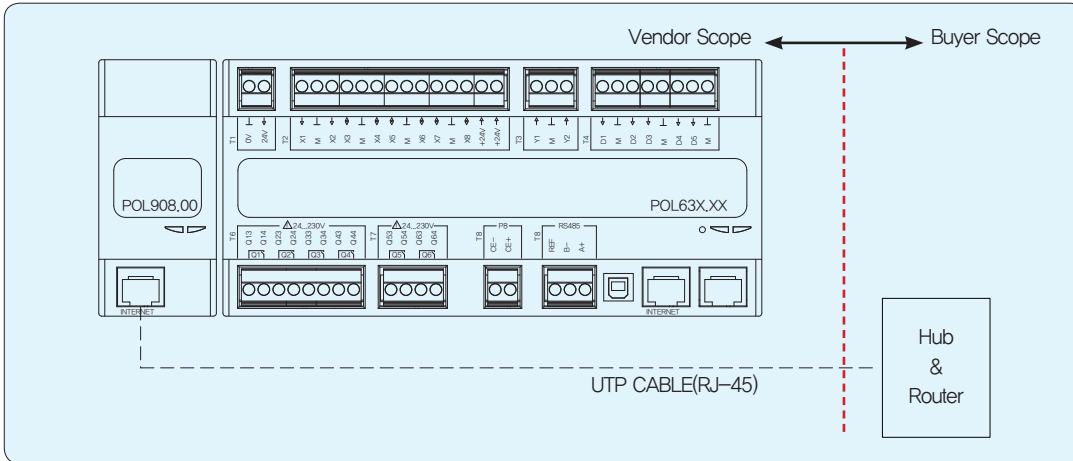

## (5) INTERNET

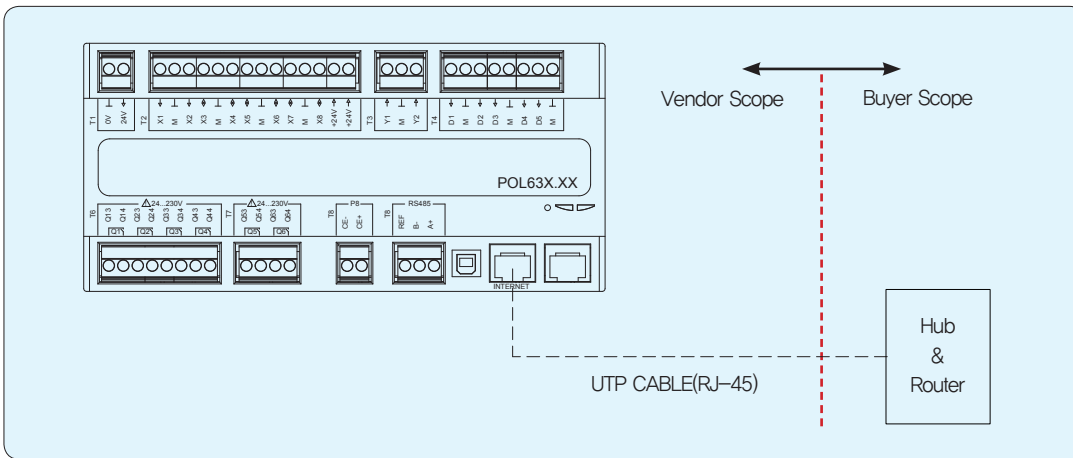

**Caution**

Use "Direct Cable" for UTP CABLE(RJ-45) if you use a hub or a router (line sharer). If not, use "Cross Cable".

## (6) MMI(SCADA SYSTEM)

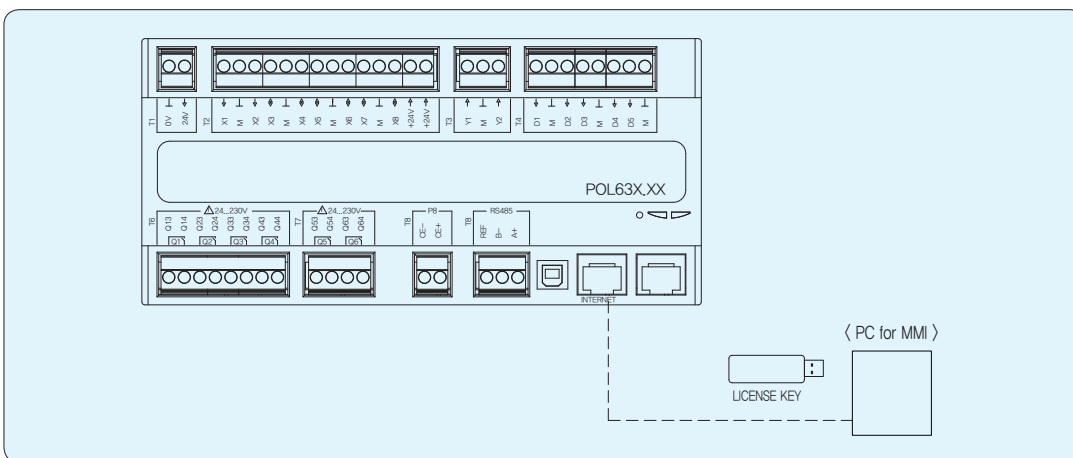

**[Note]**

Vendor Scope :  
LICENSE KEY, PC for MMI

Buyer Scope :  
Communication Cable  
between the chiller and the  
PC for MMI

**Caution**

Must use "Cross Cable" for UTP CABLE(RJ-45).



# Installation Records (Global)



Germany



**Giessen Hospital**  
CHP 292usRT (1,027kW)



**BCMG EHNINGEN**  
2AB 1031usRT(3,625kW)



Belgium



**STEENFNABRIEK**  
HWAR-L 96usRT(338kW)



France



France

**Piscine Sainte Manehoud**  
HWAR-L 40usRT(141kW)



Netherland



**University of Amsterdam**  
HWAR-L 568usRT(1,997kW)



USA



**Macy's Department Store in Brooklyn**  
HWAR-L 360usRT(1,266kW)



Australia



**Qantas Trigeneneration at Sydney Airport CHP & HWAR-L**  
3,642usRT(12,805kW)



Hungary

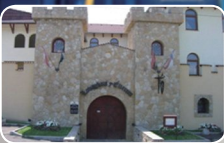

**SZT LASZLO Hotel**  
HWAR-L 145usRT(510kW)



Switzerland



**Zentralwascherei**  
HWAR-L 50usRT(176kW)



Bangladeshi



**Ismail Textile Mills Ltd**  
CHP 160usRT(563kW)





USA



**CBS Television City, with UTC**  
HWR-L 50usRT(176kW)



**UTC Power in Connecticut**  
Absorption Chiller for Fuel Cell Exhaust Gas 50usRT(176kW)

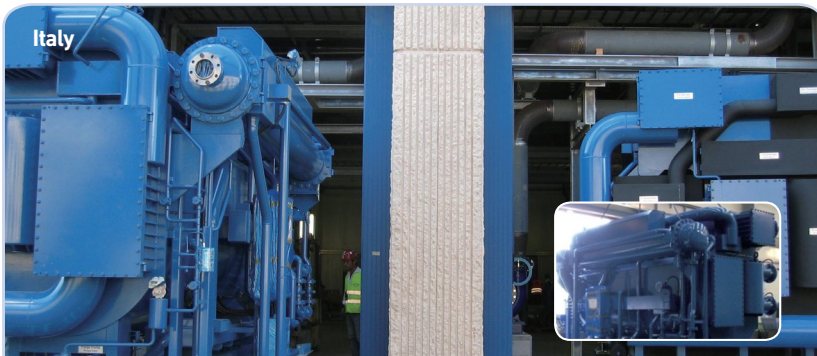

Italy



**3SUN Group Co-generation Plant in Catania**  
SW & 2AB 2,388 usRT(8,396kW)



Taiwan



**Chang Chun Miao Liao**  
2AB 830 usRT(2,918kW)

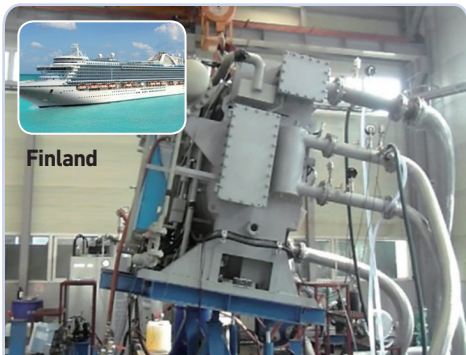

Finland



**GADLAB Engineering**  
Maritime Abs. Chiller 142usRT(500kW)



Russia



**Dovgalenko Shopping Mall in St. Petersburg**  
HWR-L375H 3 sets 9,989usRT(35,121kW)



Mexico



**Hermosillo**  
CHP 040H 400usRT(1,406kW)



Iran



**BEHESHT Residential Complex**  
DWH210 28 sets 5,880usRT(20,674kW)



Pakistan



**Shaukat Khanum Memorial Cancer Hospital**  
DW 450usRT(1,582kW)



# Installation Records (Korea)



## R&D Institutes



**Pangyo Industry-Academic Cooperation R&D Center**  
2AB 480usRT(1,688kW)



**Pangyo Samyang R&D Center**  
2AB 680usRT(2,391kW)



**Pangyo Hanhwa R&D Center**  
2AB 840usRT(2,953kW)



**CJ Onlyone R&D Center Gwangyo**  
2AB 6 sets 5,400usRT(18,986kW)

## Large Sized Building



**U-SPACE Pangyo**  
2AB 9 sets 6,295usRT(22,133kW)



**E-mart Gwangyo**  
2AB 1,050 usRT(3,692kW)

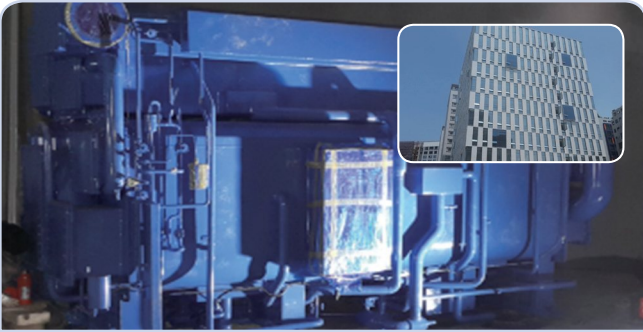

**Truebook Sinsago Co., Ltd. Magock**  
2AB 520usRT(1,828kW)



**Korea Transportation Safety Authority Gimcheon Office**  
DW 360usRT(1,266kW)



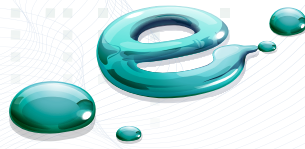

**Hwaeom Building Munjeong-dong**  
2AB 270usRT(949kW)



**Incheon International Highschool**  
2AB 1,500usRT(5,274kW)



**E-mart HeungDuck**  
2AB 455usRT(1,599kW)



**Korea Gas Corporation Daegu Office**  
2AB 1,300usRT(4,571kW)



**SK Pangyo TechnoValley**  
2AB 2,023usRT(7,113kW)



**Hanhwa SD Pangyo**  
2AB 4 sets 2,850usRT(10,021kW)



**KCC Pangyo InnoValley**  
2AB 13 sets 5,010 usRT(17,615kW)

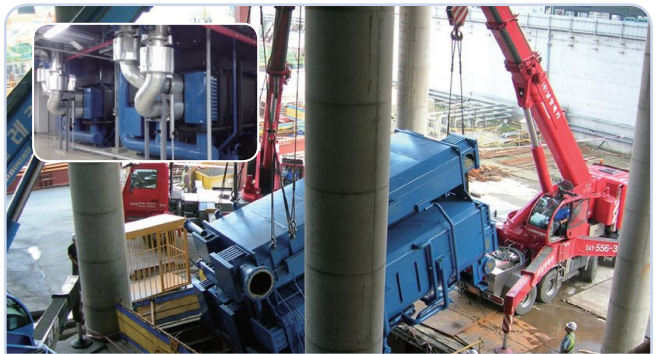

**Shindorim D-Cube City**  
2AB sets 2,250usRT(7,911kW)



## Industrial Plant



**Kumho Petro-Chemical Factory**  
HeatPump AHT (1.2barG Steam Production 8 ton/hour)



**Korea Zinc.**  
2AA 210usRT(738kW),  
Air Handling Units Chilled Water Tank, Air Duct



**Daesan Lotte Chemical D-EG1**  
2AB 1,125usRT(3,956kW)



**Hanhwa Chemical PE Manufacturing 1 Plant**  
HWAR- L 1,400usRT(4,922kW)



**Samsung Total**  
SW & HWAR-L 9,787usRT(34,411kW)



**Lotte Petro Chemical Factory**  
Explosion-Proof Steam Abs. Chiller, HWAR-L 7,800usRT(27,425kW)



**TOK**  
HWAR-L 1,100usRT(3,868kW)



**Youngpoong Seokpo Refinery**  
2AA 240usRT(844kW)



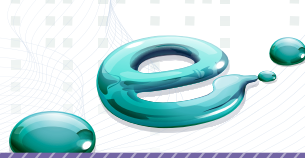

**Public Facilities**



**Korea Elevator Safety Agency**  
2AB 150usRT(527kW)



**Korea Polar Research Institute Songdo**  
2AB 210usRT(738kW)



**Sejong Government Complex**  
2AB 840usRT(2,953kW)



**Nakdonggang National Institute of Biological Resource**  
2AB 720usRT(2,532kW)



**Incheon Interational Airport**  
2AB 8 sets 8,000usRT(28,128kW)



**Yangcheon-gu Community Center**  
2AB 1,050usRT(3,692kW)



**Chungcheongnam-do Provincial Government Administration Building**  
2AB 2,400 usRT(8,438kW)



**Yongin Forest of Tranquility**  
DW 240 usRT(844kW)



We-Abs-Gen-1102-00

2019. 01. Print



World Energy

**World Energy Co., Ltd.**

**Office**

97, Gaeungongdan-gil, Gaeun-eup, Mungyeong-si, Gyeongsangbuk-do, 36995, Rep. of KOREA  
www.worldenergy.co.kr Tel. 82-31-501-2706 Fax. 82-31-501-2705

